

INSTRUCTION MANUAL

Rotating Shadow Band

# RSB-02

for MS-80SH Plus+

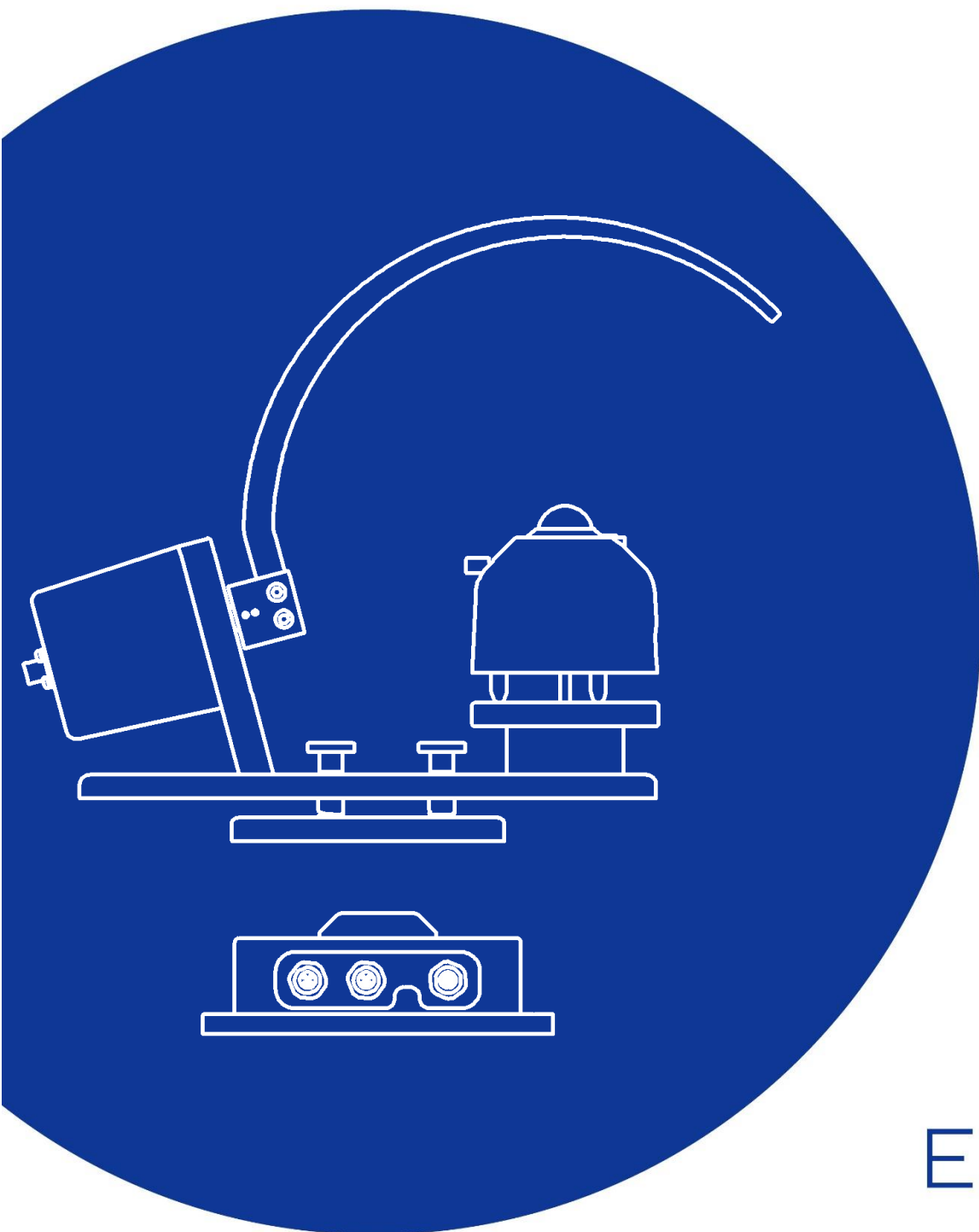

EKO

<b>1</b>	<b>Contents.....</b>	<b>2</b>
<b>2</b>	<b>Important User Information .....</b>	<b>4</b>
2-1	Contact Information .....	4
2-2	Warranty and Liability.....	4
2-3	About the Instruction Manual.....	5
2-4	Environment .....	5
2-5	ISO/IEC 17025.....	6
2-6	CE declaration.....	7
<b>3</b>	<b>Safety Information.....</b>	<b>8</b>
3-1	General Warnings.....	8
<b>4</b>	<b>Product Overview.....</b>	<b>10</b>
4-1	Main Features .....	10
4-2	System Configuration.....	11
4-3	Working modes .....	12
4-4	System Configuration.....	13
<b>5</b>	<b>Installation .....</b>	<b>14</b>
5-1	Checking Contents .....	14
5-2	Required Tools & Devices .....	15
5-3	Checking Installation Location .....	15
5-4	Main Unit Assembly .....	16
5-5	RSB-02 Installation .....	19
5-6	Wiring.....	22
5-7	Communication Settings .....	25
<b>6</b>	<b>Start up .....</b>	<b>26</b>
6-1	Startup Checks.....	26
6-2	Measurement.....	28
6-3	Change working mode.....	29
<b>7</b>	<b>Maintenance and Troubleshooting .....</b>	<b>30</b>
7-1	Maintenance .....	30
7-2	Troubleshooting .....	33
<b>8</b>	<b>Specification.....</b>	<b>34</b>
8-1	RSB-02 Main Unit .....	34
8-2	C-BOX .....	35
8-3	Pyranometer (MS-80S/SH).....	36
8-4	Dimensions.....	38

8-5 Cable ..... 40

8-6 Accessories List..... 40

**APPENDIX ..... 41**

A-1. Radiometric Terms..... 41

A-2. Communication specifications ..... 42

A-3. Software (Obi)..... 47

A-4. Updating Firmware and Software ..... 72

## 2 Important User Information

Thank you for using EKO Products.

We recommend you to read this manual prior to installation and operation of the product. Keep the manual in a safe and handy place for whenever it is needed. For any questions, please contact us at below:

### 2-1 Contact Information

EKO INSTRUMENTS CO., LTD.		
<b>Asia, Oceania Region</b>		
www.eko-instruments.com info@eko-instruments.com	EKO INSTRUMENTS Co., Ltd. 1-21-8, Hatagaya, Shibuya-ku Tokyo, 151-0072 Japan	Tel: +81 [3] 3469-6713 Fax: +81 [3] 3469-6719
<b>Europe, Middle East, Africa, South America Region</b>		
www.eko-instruments.com sales-eu@eko-instruments.com	EKO INSTRUMENTS Europe B.V. Lulofsstraat 55, Unit 28, 2521 AL, Den Haag, The Netherlands	Tel: +31 [0]70 3050117
<b>North America Region</b>		
www.eko-instruments.com sales-usa@eko-instruments.com	EKO INSTRUMENTS USA Inc. 2570 North First Street, Suite 200 San Jose, CA 95131 USA	Tel: +1 408-977-7751 Fax: +1 408-977-7741

### 2-2 Warranty and Liability

For warranty terms and conditions, please contact EKO Instruments or your distributor for further details.

EKO guarantees that all products have been tested to ensure the instrument meets its published specifications. The product warranty is valid only if the product has been installed and used according to the instructions provided in this operating manual.

In case any manufacturing defect[s] will occur, the defective part[s] will be repaired or replaced under warranty; however, the warranty will not be applicable if:

- Any modification or repair has been done by anyone other than EKO service personnel.
- The damage or defect is caused by disrespecting the specifications published on the Product Sheet or Manual.
- There is discoloration of the main unit or box enclosure, shadow band plate, and cable within a range that does not affect the function and performance of the product.

## 2-3 About the Instruction Manual

---

Copy Rights Reserved by EKO INSTRUMENTS CO., LTD.

Making copies of whole or parts of this document without permission from EKO is prohibited.

This manual was issued: August 29, 2025

Version Number: 2

## 2-4 Environment

---

### 1. WEEE Directive

[Waste Electrical and Electronic Equipment]



Although this product is not subject to the WEEE Directive 2002/96/EC, please make sure that it should not be disposed of in a landfill or with municipal or household waste. For proper processing, collection and recycling, please contact a specialist collection site or facility.

Disposing of this product correctly will help save valuable resources and prevent any potential negative effects on human health and the environment, which could otherwise arise from inappropriate waste handling.

### 2. RoHS Directive

EKO Instruments has completed a comprehensive evaluation of its product range to ensure compliance with RoHS Directive 2011/65/EU+(EU)2015/863 regarding maximum concentration values for substances. As a result, all products are manufactured using raw materials whose concentration levels are less than the hazardous substances specified in RoHS Directive 2011/65/EU+ (EU) 2015/863.

## 2-5 ISO/IEC 17025

---

EKO Instruments Co. Ltd. calibration laboratory is accredited by Perry Johnson Laboratory Accreditation, Inc. [PJLA] to perform pyranometer and pyr heliometer calibrations in accordance with the requirements of ISO/IEC17025, which are relevant to calibration and testing.

Based on the applied calibration methods EKO provides the best quality solar sensor calibrations compliant to the international standards defined by ISO/IEC17025 / 9847 [Indoor method] and ISO9059 [Outdoor method] [Accreditation number : #74158 / [www.pjlab.com](http://www.pjlab.com)]

ISO/IEC17025 provides a globally accepted basis for laboratory accreditation that specifies management and technical requirements. With calibrations performed at the EKO Instruments laboratory we enable our customers to:

- Clearly identify the applied calibration methods and precision
- Be traceable to the World Radiation Reference [WRR] through defined industrial standards:
  - ISO9846 Calibration of a pyranometer using a pyr heliometer
  - ISO9847 Calibration of pyranometers by comparison to a reference pyranometer
  - ISO9059 Calibration of field pyr heliometers by comparison to a reference pyr heliometer
- Obtain repeatable and reliable calibration test results through consistent operations

Our clients will obtain highly reliable data by using an ISO/IEC17025 calibrated sensor. Our Accredited lab is regularly re-examined to ensure that it maintains the required standard of technical expertise.

## 2-6 CE declaration

---



IMPORTANT USER INFORMATION

---



### DECLARATION OF CONFORMITY

We: EKO INSTRUMENTS CO., LTD 1-21-8  
 Hatagaya Shibuya-ku, Tokyo 151-0072  
 JAPAN

Declare under our sole responsibility that the product:

Product Name : Rotating shadow band  
 Model No. : RSB-02

To which this declaration relates is in conformity with the following harmonized standards of other normative documents:

Harmonized standards:

EN IEC 61326-1:2021 Class A [Emission]  
 EN IEC 61326-1:2021 [Immunity]

Following the provisions of the directive:

EMC-directive: 2014/30/EU

Machinery-directive: 2006/42/EC

Date: August 30, 2024

Position of Authorized Signatory: Senior Manager of R&D Center

Name of Authorized Signatory: Hitoshi Yokemura

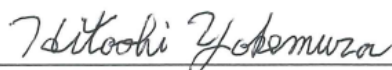
Signature of Authorized Signatory: 

# 3 Safety Information

EKO Products are designed and manufactured with consideration for safety; however, please make sure to read and understand this instruction manual thoroughly to be able to operate the instrument in the correct manner.

 <b>WARNING CAUTION</b>	Attention to the user; please pay close attention to the instructions accompanied by this caution sign.
--	---

 <b>HIGH VOLTAGE WARNING</b>	High voltage is used; please pay special attention to instructions accompanied by this high-voltage warning sign, to prevent electric leakage and/or electric shocks.
---	---

## 3-1 General Warnings

---

### 3-1-1. Setup

- Always wear gloves and protective glasses when installing this product. This will prevent unexpected injury.
- The installation base or mast should have enough load capacity for the instrument to be mounted. Fix the instrument securely to the base or mast with bolts and nuts; to avoid the instrument dropping due to a gale, an earthquake, or other unexpected events.
- Make sure to install the instrument and cables in a suitable location, and avoid submerging them in water.
- Insert the output cable into the connector port on the sensor, main unit, and control box, and tighten it all the way. Push the connector in, and check to make sure the screw is tight. If the connection is loose, water can enter the unit and cause it to malfunction.
- The shield wire of the output cable of the control box must be connected to the ground earth. Otherwise, the surge protection circuit inside the control box will not operate properly if the shield wire is not connected to the ground earth.
- When using MS-80SH as a pyranometer for measurement, make sure to install the provided fixed foot. If the bottom of the pyranometer directly contacts the mounting base, the dome heating effect cannot be fully satisfied.
- Although this product is tested to meet EMC Directive compliance requirements, it may not fully satisfy its primary specification/performance when using this product near locations where a strong electromagnetic wave is generated, for example:  
Outdoor: High voltage power line, power receiver/distribution facility, etc.  
Indoor: Large-size chiller, large rotation device, microwave, etc.

- Do not use this product in environments where corrosive gasses, such as ammonia and sulfuric acid gas, are generated. It may cause malfunction.
- Do not install in an area likely to result in salt damage. It may cause malfunction by corrosion of the drive unit parts.
- Do not use this instrument in a vacuum environment.
- For proper grounding use the original cable provided.
- If the cable and main unit are at risk for getting damaged by birds and small animals, protect the cable and the main unit by using:
  1. Reflective tape
  2. Repellent
  3. Cable duct
  4. Installing bird-spikes
- The settings can be changed using an RS-485 to USB converter and the dedicated software Obi.

### 3-1-2. Handling

- When installing or carrying the main unit, do not lift it by the shadow band. The band may break, causing injury to the human body due to falling.
- Never touch the shadow band after starting the measurement. The movement of the band may cause unexpected human injury.
- Do not approach this device other than operators. The band part suddenly moves.

### 3-1-3. Signal Cable / Power supply

- Be sure to use the signal cable attached to the product.
- When using the optional shielded cable with connector (20 m or 30 m), be sure to set a power supply voltage to 24 VDC.
- For safety and protection, it is recommended that a circuit breaker is inserted in the power supply line to the instrument.
- Ensure the signal cable is properly grounded. The shield wire of the control box's output cable must be connected to the earth ground. Insufficient grounding can lead to measurement errors due to noise, as well as potential electric shock and leakage accidents.
- Check the voltage and types of the specified power supply before connecting this instrument. When improper power supply is connected, it may cause malfunction and/or an accident.
- Connect a 2.5A slow blow fuse in series with the power supply line when using this instrument. Operating without the fuse could result in excessive current flow, which may cause overheating, internal damage to the electronics, or even a fire.

### 3-1-4. About RS485 (Modbus RTU) connection

- This product supports communication through the RS-485 Modbus RTU.
- Depending on the USB-RS485 converter type, an additional termination resistor (120Ω) and/or pull-up/pull-down resistor (680Ω) is required for proper communication.

# 4 Product Overview

## 4-1 Main Features

---

### Rotating Shadow Band and Pyranometer

- The RSB-02 digitally controls the rotation of a motor-driven shadow band to periodically block light from a pyranometer (MS-80S/SH). This enables accurate measurement of Global Horizontal Irradiance (GHI), Diffuse Horizontal Irradiance (DHI), and Direct Normal Irradiance (DNI) which are traditionally measured using a tracking method.
- DNI is calculated from the measured values for GHI and DHI.

### C-BOX (Smart processing interface unit)

- The C-Box controls system operation and pyranometers (MS-80S/SH) measurement, and processes measurement data.
- Measurement data is sent as a Modbus signal through an RS-485 serial interface to the data logger and Photovoltaic (PV) monitoring devices.
- A built-in GPS receiver acquires position and time information needed for shadow band control.

## 4-2 System Configuration

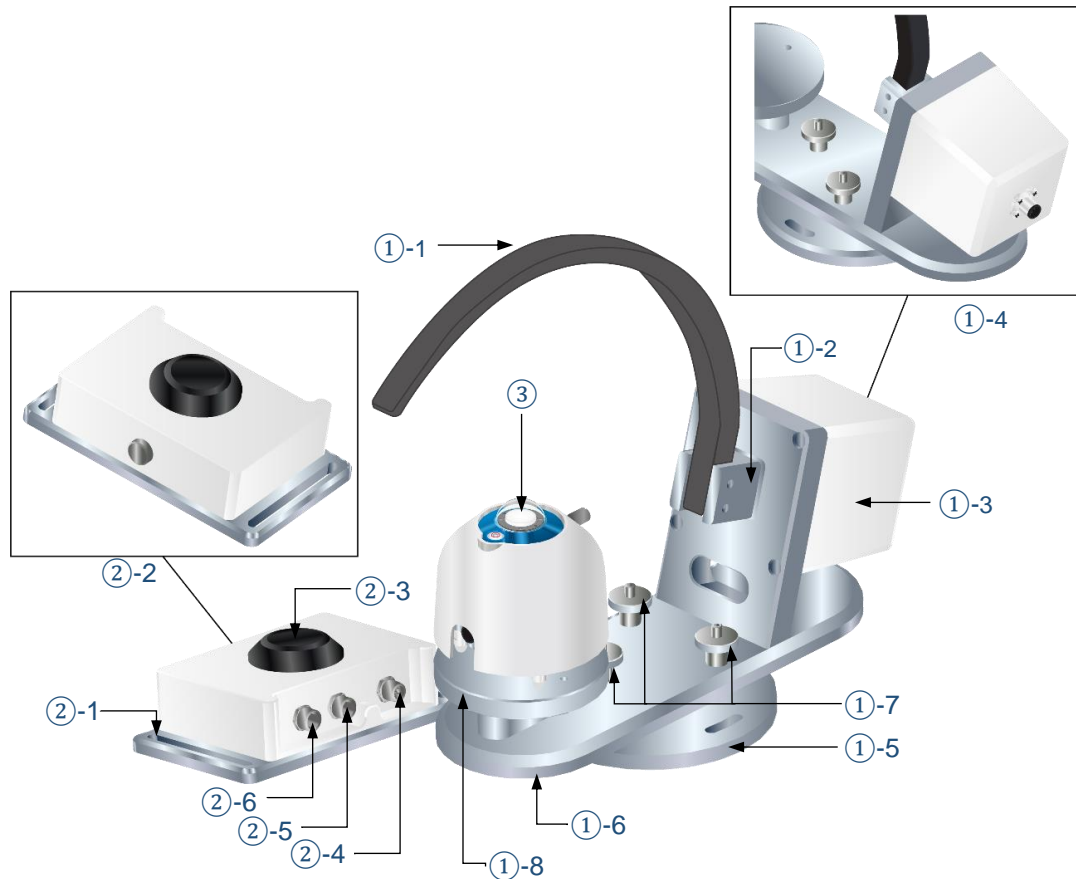

NO.	Unit name	Sym.	Parts name	Function	
①	RSB-02 (Rotating Shadow Band)	①-1	Shadow band	A band to cover the direct normal irradiance component to the pyranometer.	
		①-2	Band holder	Holder for attaching the "Shadow band" to the motor shaft.	
		①-3	Motor & Housing	Drives shadow band rotation and performs position control.	
		①-4	Cable connector	Connector to connect the cable from the control unit.	
		①-5	Base	A base to be mounted in place.	
		①-6	Main plate	Central plate of the main unit.	
		①-7	Leveling screw	Adjusting the level of the "Main plate".	
		①-8	Sensor stand	Installation stand for a pyranometer.	
②	Connector unit (C-BOX)	②-1	Mounting hole	Fastening holes for fixing the C-BOX.	
		②-2	Air vent cap	Adjusting the same pressure between the inside and outside of the C-BOX.	
		②-3	GPS sensor	Acquiring location and time information of the installation point.	
		Cable connector	②-4	COM OUTPUT	Connecting port for data communication and power supply to DAQ(data acquisition) system.
			②-5	RSB	Connecting port for data communication to RSB-02.
			②-6	MS-80S/SH	Connecting port data received from Pyranometer.
③	Pyranometer (MS-80S/MS-80SH)		Pyranometer for measuring GHI and DHI.		

## 4-3 Working modes

---

The RSB-02 measures GHI and DHI, and calculates DNI, by moving the shadow band to shade the pyranometer and measuring the irradiance when shaded.

The RSB-02 has two working modes that employ different measurement methods. You also have the option to add another pyranometer.

- RSB (Rotating Shadow Band) mode

This working mode intermittently shades the pyranometer. A single pyranometer measures GHI and DHI, and calculates DNI.

The measured value is updated every 15 seconds.

Pyranometer 1: measures GHI, DHI, and calculates DNI

Pyranometer 2: Use the optional pyranometer to measure RHI (Reflected Horizontal Irradiance), and determine the albedo (Reflected light/Incident light).

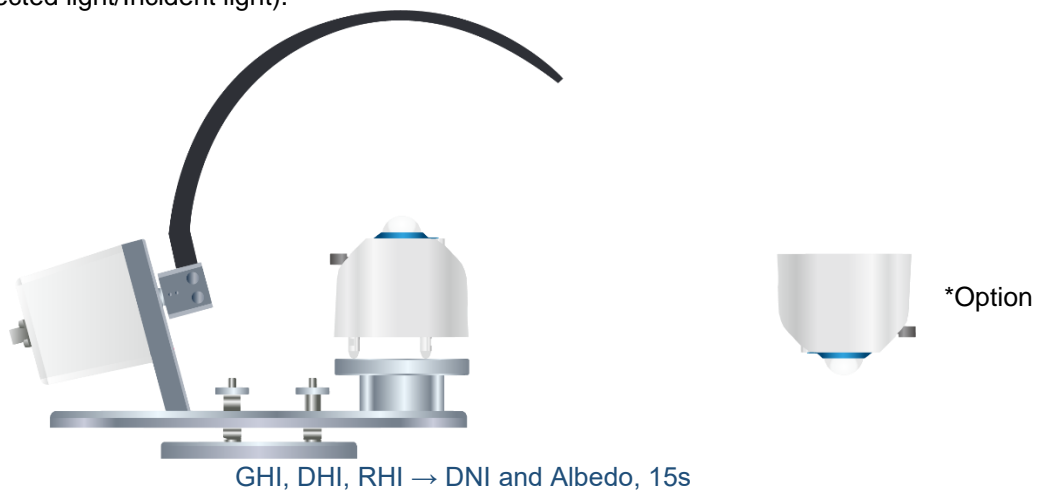

- TSB (Tracking Shadow Band) mode

This working mode continuously shades the pyranometer by tracking the movement of the sun. It measures DHI. The measured value is updated every second.

Pyranometer 1: measures DHI

Pyranometer 2: Use the optional pyranometer to measure GHI, and calculate DNI.

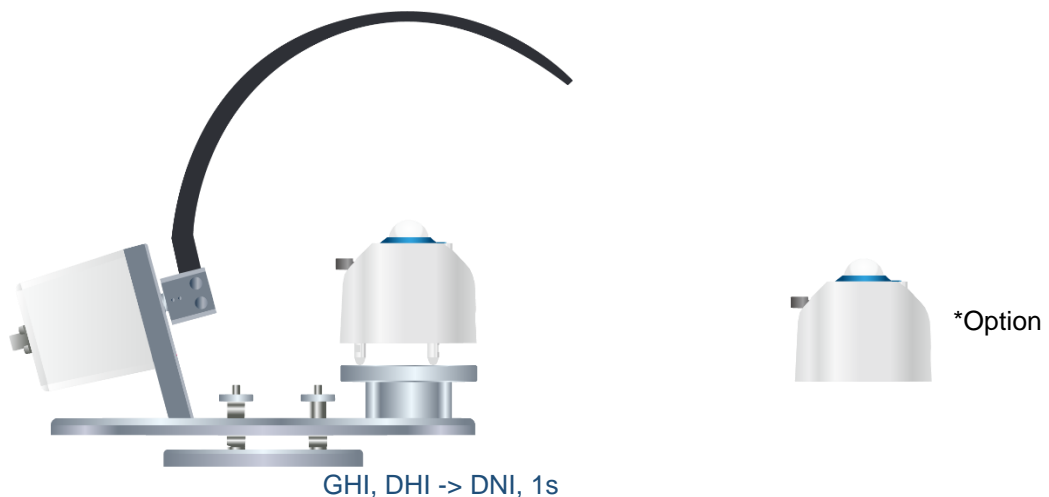

## 4-4 System Configuration

The measurement system is made up of the RSB-02, C-BOX, and pyranometer. Measured values are collected by the data logger using RS485 (Modbus RTU) communication. The equipment can be configured from a PC using RS-485 (Modbus RTU) communication.

### Rotating Shadow Band



### C-BOX



### Customer Prepared

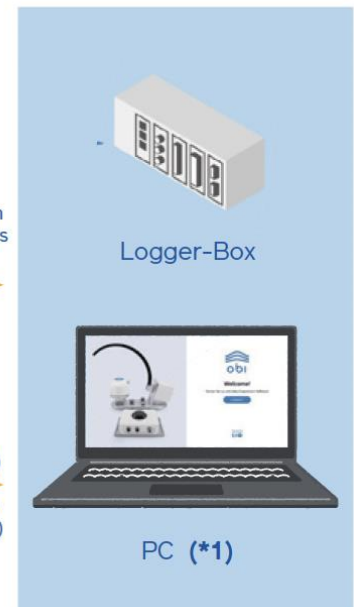







\*1 Equipment configuration can be performed by connecting the C-BOX to a PC using RS-485 (Modbus RTU) communication.

You will need to prepare an RS485-USB interface yourself. Use our dedicated Obi software, or the Modbus commands listed in Appendix A-2 of this manual, to configure the equipment.

# 5 Installation

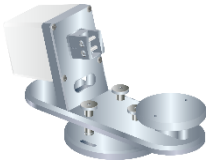
## 5-1 Checking Contents

Make sure that nothing is missing or damaged. In the unlikely event of a problem, refer to the manual and please contact us.

Name/Specification	Quantity	Note
Shadow band 	1	<ul style="list-style-type: none"> <li>Attach the shadow band and pyranometer to the RSB-02 unit before use. (→Pg. 16 “5-4 Main Unit Assembly”)</li> <li>The pyranometer is not included, so please make sure to prepare one separately.</li> </ul> <div style="border: 1px solid black; padding: 5px; margin-top: 10px;">  The MS-80 (analog output) cannot be used.                 </div>
Pyranometer (MS-80SH or MS-80S) 		
RSB-02 Main Unit 	1	
Cable (1.5m Shielded cable with both straight connector)	1	
Cable (1.5m Shielded cable with straight - angled connector)	1	
Fixed foot 	2	
Pyranometer mounting bolt set (M5 × 30 mm)	2	
RSB-02 mounting bolt set (M6 × 50 mm)	2	
Washer (M6)	4	
Nut (M6)	2	
C-BOX 	1	Attach the pyranometer and RSB-02 unit to the DAQ to control measurements. (→Pg. 23 “5-6-2 Connecting to each piece of equipment”)
Cable (Standard 10 m, Option 20m, 30m : Shielded cable with connector) 	1	Standard length of shielded cable with connector is 10m. 20m and 30m cables are also available as options.
C-BOX mounting bolt set (M6 × 50 mm)	2	(→Pg. 40 “8-6 Accessories List”)
Washer (M6)	4	
Nut (M6)	2	
Quick Start Guide	1	
Instruction Manual		Download from our website.

## 5-2 Required Tools & Devices

---



Wrench

Allen Key  
(4 & 5mm)

DAQ

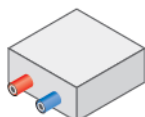
DC Power Supply  
(12-24V)OBI  
Software

RS485 to USB Converter

## 5-3 Checking Installation Location

---

This product must be installed in a location that fulfills the following conditions;

- A visibility angle of 180° with nothing to obstruct sunlight over the entire area (at minimum, this should be a place with a solar altitude angle of 5° or more, and no cover).
- Free from shadows cast by structures like steel towers and buildings.
- There are no brightly colored walls or signboards nearby that could easily reflect sunlight.
- Easy access for conducting regular maintenance (cleaning the glass dome, etc.).

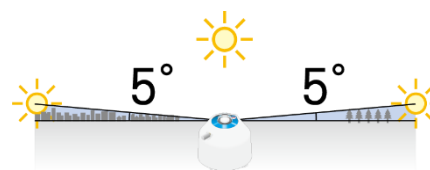

## 5-4 Main Unit Assembly

---

Attach the shadow band and the pyranometer to the RSB-02 unit.

Tools used : Hex wrench 4mm

✓ Also see the Quick Start Guide (QSG) attached to the product.

**1** Attach the shadow band to the band holder as shown in the figure below.

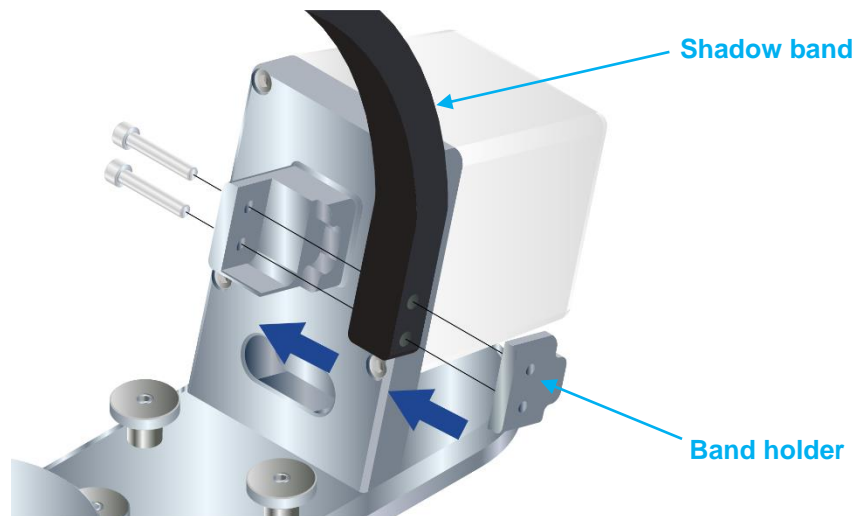

**2** Tighten the two bolts with a hex wrench (4 mm).



- Fully tighten the two bolts. (Specified torque: 3 Nm)
- After tightening, confirm that the shadow band does not rattle.

- 3 Remove the pyranometer leveling foot (2 pcs)  
Attach the fixed foot included (2 pcs)**

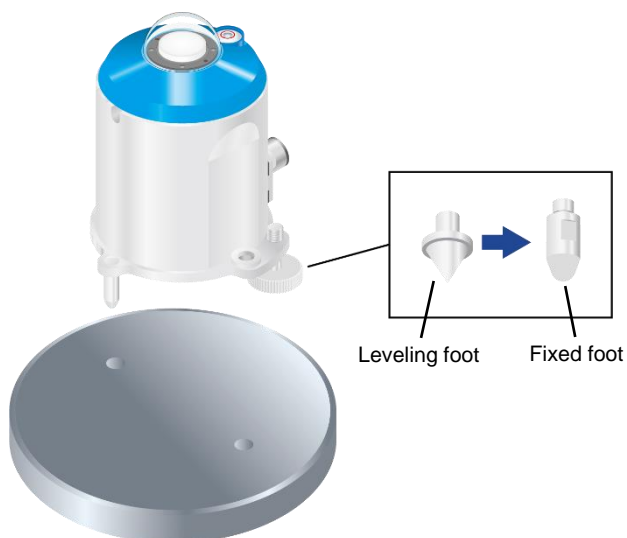

- 4** ① Place the pyranometer on the RSB-02 unit, and align the mounting holes.  
② Put the washers (M5) onto the included cap bolts (M5×30mm) and insert these into the pyranometer mounting holes.  
③ Tighten the cap bolts with a hex wrench. (4 mm, Specified torque: 2.0 Nm)

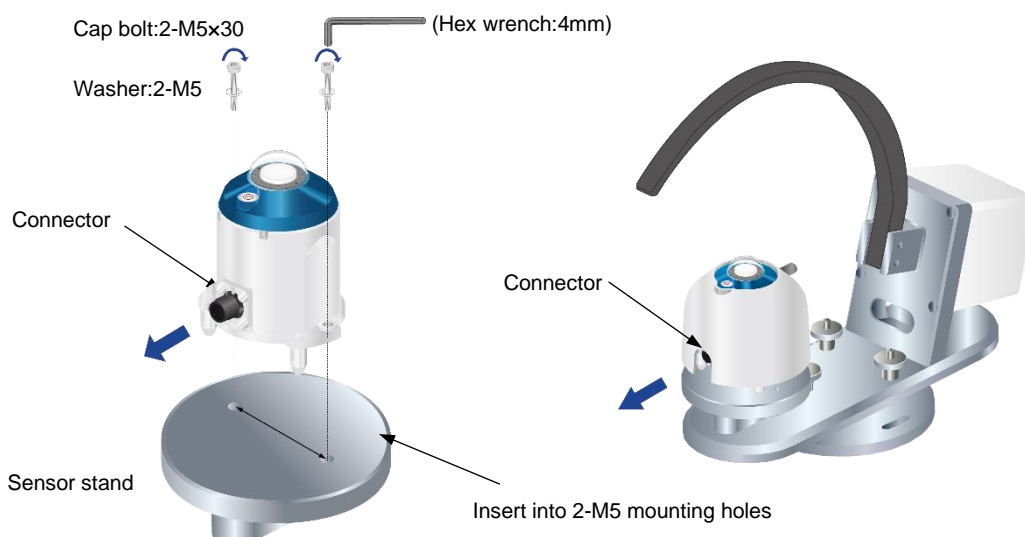

Install the pyranometer cable connector so that it faces the outside of the rotating shadow band main unit.

- 5** ① Orient so that the spirit level on the pyranometer can be seen through the cutout in the sun screen.
- ② Place the sun screen on so that the two protrusions on the inside of the sun screen slip into the notches on the pyranometer.
- ③ Hand tighten the sun screen mounting screw (knurled screw).
- ④ Make sure that the sun screen does not come off.

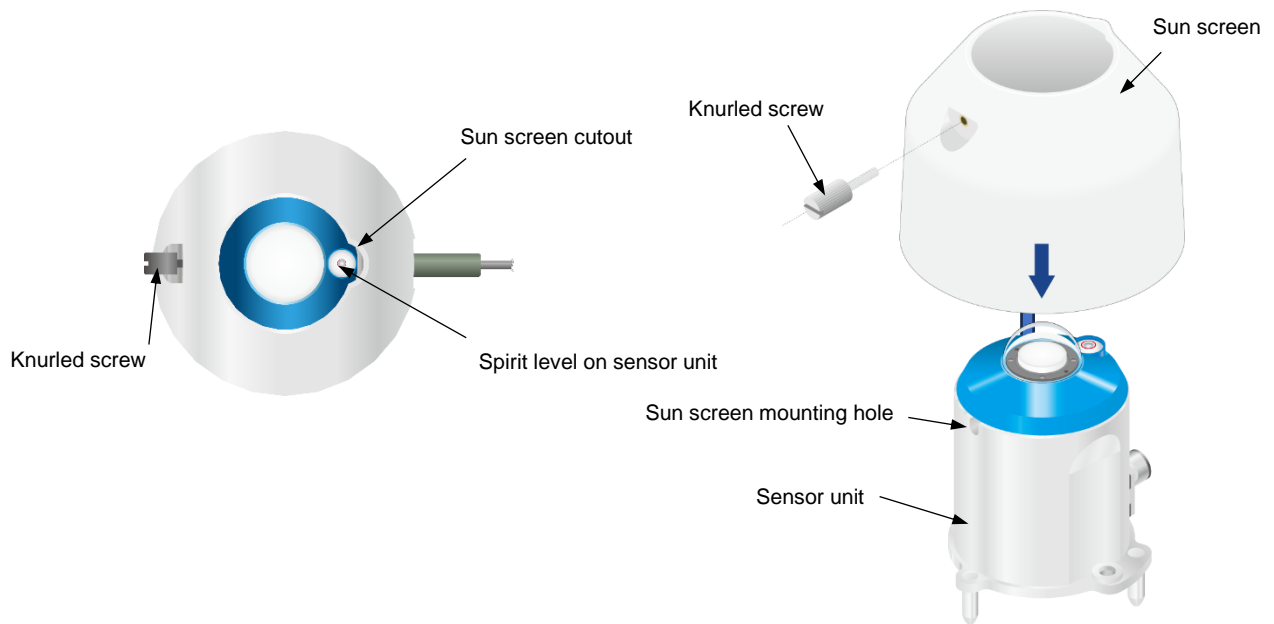

## 5-5 RSB-02 Installation

Install the RSB-02 in the measurement location.

### 5-5-1 Determining Installation Orientation

The RSB-02 must be installed with the motor axis pointing towards the position of the sun at culmination time (the moment when the sun is at its highest point due south).

Because the shadow band blocks sunlight, the installation orientation will differ between the northern and southern hemispheres.

**1** Prepare a setup base with fixing holes for the RSB-02 base plate.

**2** Make sure the motor is facing the equator.

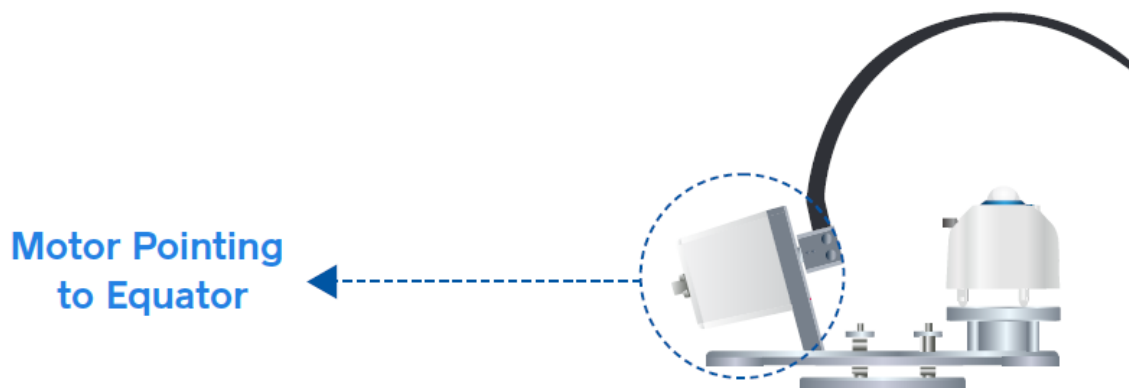

**3** Check for direct sunlight - sunny day!  
In the case of absence of direct sunlight, you can use a compass - be aware of magnetic declination.



A magnetic compass may be used to determine the north-south direction if there is no direct sunlight because the sun is blocked by clouds. However, please note that there is a difference between the north-south indication shown on the magnetic compass, and the actual direction. You will need to correct for this deviation during installation.

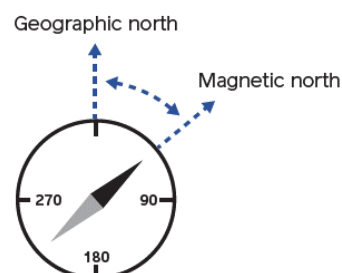

**4** Set the band in TSB mode.

## 5-5-2 Adjusting Installation Orientation

- 1 Position the band so that its shadow aligns with the center of the pyranometer's dome.

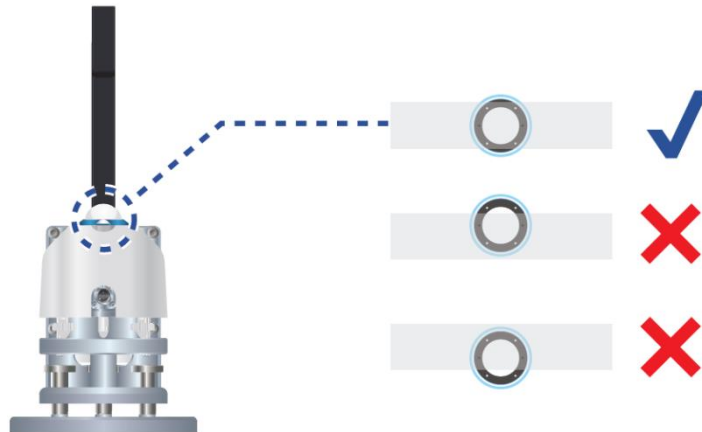

- 2 Securing the RSB-02 main unit to the installation location with the two bolts. (Specified torque: 5.2 Nm)

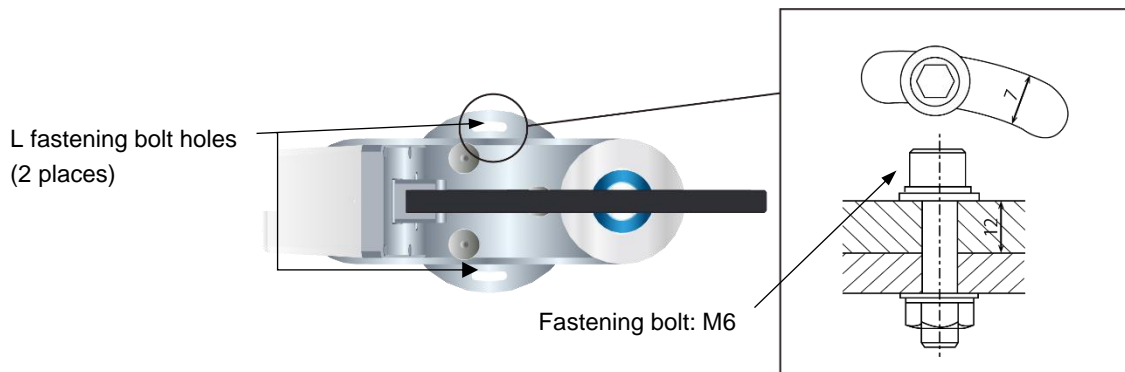

### 5-5-3 Leveling

Once you have secured the RSB-02 in the measurement location, adjust the pyranometer so that it is level.

Adjust the unit by turning the three leveling screws by hand until the air bubble in the leveling gauge on top of the pyranometer is centered. (Spirit level sensitivity:  $0.1^\circ$ ); Use no. 1 and no. 2 to move the bubble sideways and no.3 to center it.

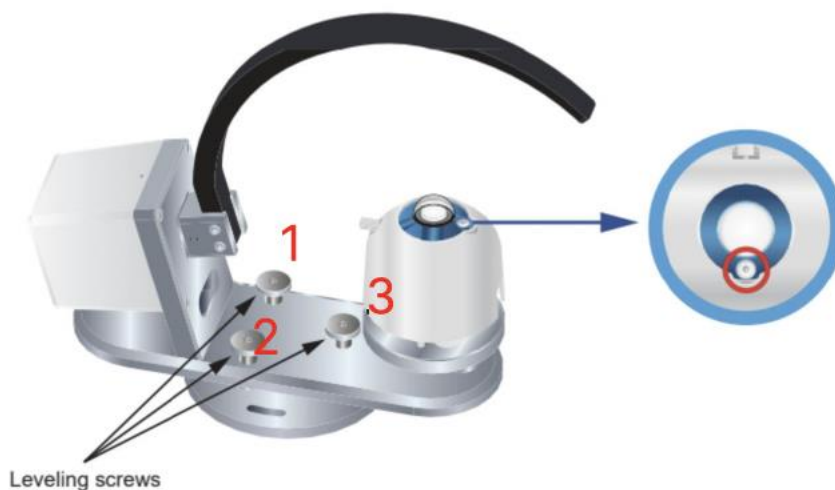

Deviation from a horizontal position may lead to an errors between the orientation and angle of incidence. Regularly check that the equipment is level.

### 5-5-4 Securing the C-BOX

Place the C-BOX as close to the RSB-02 main unit as possible, to minimize the effects of GPS signal error and noise. However, please maintain a distance that does not affect the operation of the shadow band. Use the same method to secure it as for the main body. Secure the C-BOX to the installation base with the two bolts, washers and nuts (M6).

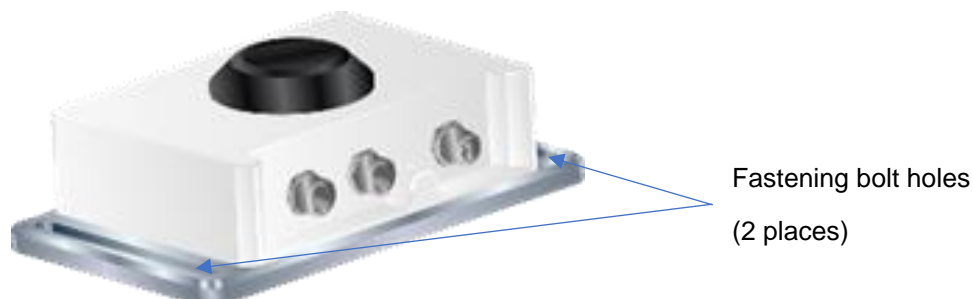

## 5-6 Wiring

---

### 5-6-1 Cable Precautions

Item	Recommended action
Handling environment	For long-term stability, route cables through trenches or pipes so that they will not be exposed to direct sunlight, wind, and rain.
Countermeasures against noise	<ul style="list-style-type: none"><li>· When routing cables in exposed outdoor locations, secure them with fasteners to prevent the wind from causing them to vibrate.</li><li>· Be sure to use the included cable.</li><li>· The way the cable is routed may result in noise. Install wiring away from sources of electromagnetic induction noise such as AC power supplies, high-voltage wires, and mobile phone base stations.</li></ul>

## 5-6-2 Connecting to each piece of equipment

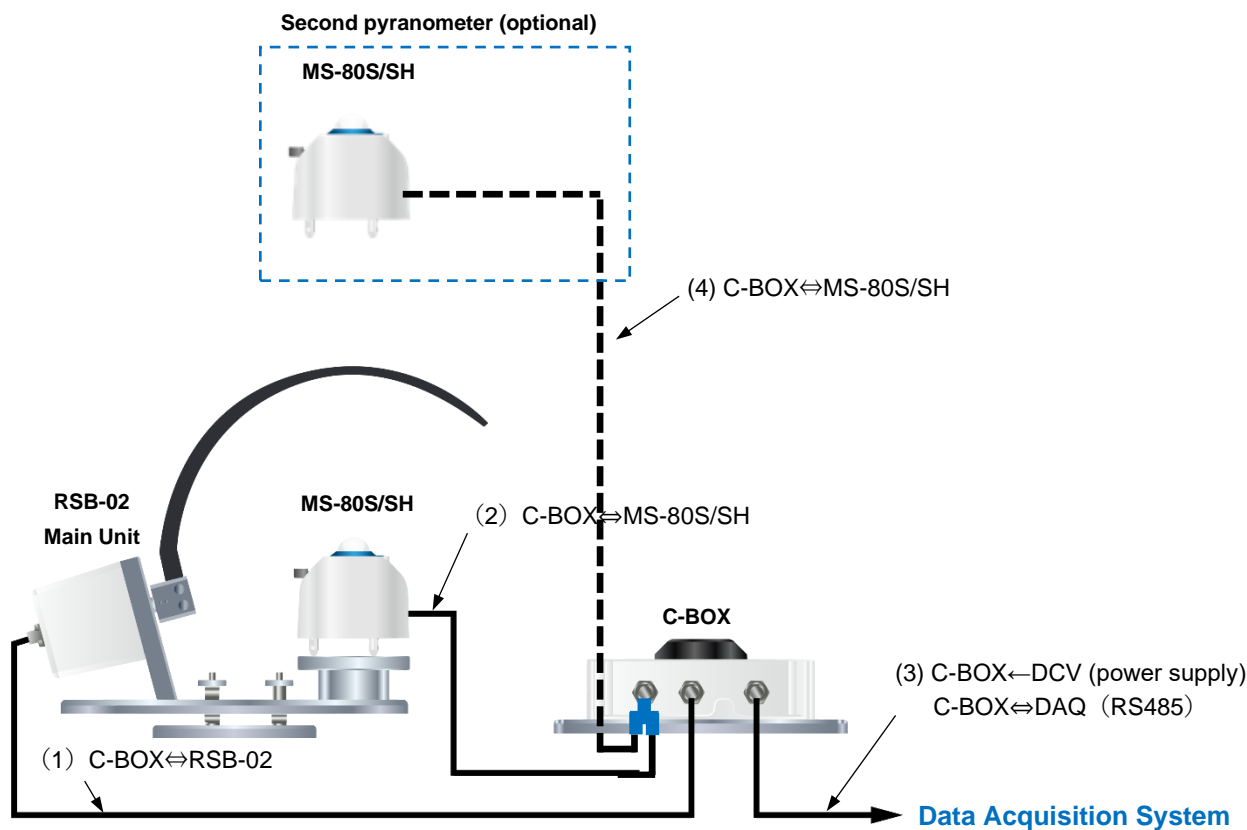

✓ For proper grounding use the original cable provided.

NO.	Function	Cable specifications							Note
		C-BOX connector label			Pyranometer	RSB-02 unit	DAQ	Length	
		MS-80SH	RSB	COM OUTPUT					
(1)	Connect the RSB-02 signal cable to Main Unit and C-BOX	—	Male: M12, Straight	—	—	Female: M12, Angled	—	1.5m	
(2)	Communication between pyranometer and C-BOX	Male: M12, Straight	—	—	Female: M12, Straight	—	—	1.5m	
(3)	Power supply and communication with the data logger through RS485 (Modbus RTU)	—	—	Female: M12, Straight	—	—	Rod terminal	Standard 10m, Option 20m, 30m	Power supply <sup>(*)</sup> : 12 to 24 Vdc (6W)
(4)	Communication between pyranometer and C-BOX	Male: M12, Straight	—	—	Female: M12, Straight	—	—	1.5m	Use the optional T-branch connector

(\*1) When using the optional shielded cable with connector (20 m or 30 m), be sure to set a power supply voltage to 24 VDC.

The connection lines to the DAQ are arranged as follows. Connect wires No. 1 and No. 2 to the terminals of the power supply (12 to 24V DC). Make sure to connect a fuse (2.5A slow blow fuse) in series to wire No.1.

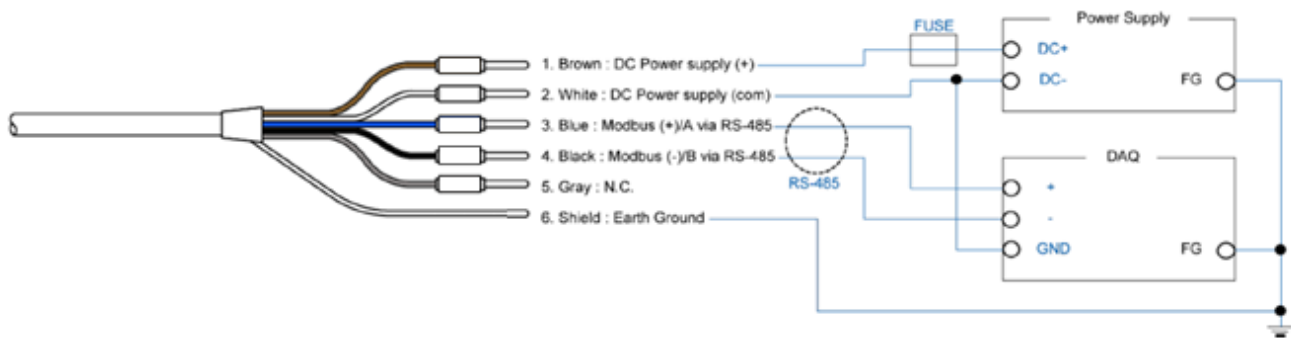

- ✓ The shield wire of the output cable of the control box must be connected to the ground earth. Otherwise, the surge protection circuit inside the control box will not operate properly if the shield wire is not connected to the ground earth.
- ✓ The RSB-02 does not have a power switch. For safety and protection purposes, it is recommended to install a circuit breaker between the C-BOX and the power supply.

## 5-7 Communication Settings

To set up communications, use the included Obi applications software, or enter the setting values into the appropriate registers by connecting the RS-485 (Modbus RTU) to the C-BOX. Refer to Appendix A-2 for details about communication specifications.

The C-BOX comes with the following communication settings when shipped from the factory. In order to connect a pyranometer, the address of the pyranometer must be configured in the C-BOX.

Check the serial number of the pyranometer. The address of the pyranometer is the last two digits of its product serial number. If the last two digits are "00" the address will be "100".

	C-BOX communication settings (factory settings)			
	Communication speed	Address	Stop bit	Parity bit
Data logger ↔ C-BOX	19.2 kbps	1	1 bit	Even
C-BOX ↔ Pyranometer	19.2 kbps	2	1 bit	Even
C-BOX ↔ Pyranometer (2nd unit / optional)	19.2 kbps	3	1 bit	Even

### 5-7-1 Connecting the first pyranometer

Use the included Obi applications software (check Annex A-3), or follow the steps below to configure.

- 1** Set register 69 GHI\_NODE\_ADDR to the address of the first pyranometer
- 2** Set register 64 UPDATE to 1
- 3** Turn the system off and then on again

### 5-7-2 Connecting the second pyranometer

Use the included Obi applications software (Check Annex A-3), or follow the steps below to configure.

- 1** Set register 72 PYR2\_ENABLED to 1
- 2** Set register 71 EXT\_NODE\_ADDR to the address of the second pyranometer
- 3** Set register 70 EXT\_SENSOR to 3
- 4** Set register 64 UPDATE to 1
- 5** Turn the system off and then on again

# 6 Start up

## 6-1 Startup Checks

---

After wiring up and supplying power to the RSB-02, the GPS on the C-BOX will acquire position and time information and start measurement automatically.

- Position of shadow band

In RSB mode, the shadow band moves between 4 levels every 15 seconds, as shown in the figure below. This action is performed to reduce the measurement error. In TSB mode, the band moves constantly to follow the sun.

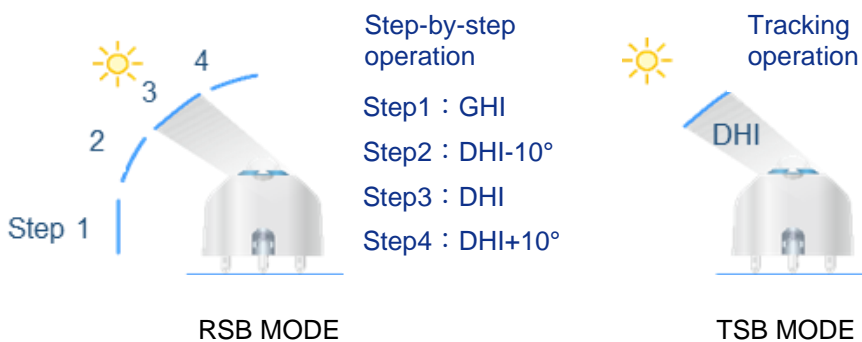

Follow the steps below to check the operation.

- 1** After powering on, once the GPS signal is successfully acquired, shadow band operation starts in accordance with each working mode. First, confirm that shadow band operation starts in accordance with each working mode (\*).

\* Operation will not start at night, after the sun sets, or when a reliable GPS signal cannot be obtained.

- 2** Confirm that the photosensitive area of the pyranometer (diffuser) is completely shaded when the band is in Step 3 of RSB mode, and at all times in TSB mode.

**3** The shadow of the shadow band is narrowest at solar noon, so this is when you should follow procedure 2 to check whether the photosensitive area of the pyranometer (diffuser) is completely shaded.

Refer to the figure below.

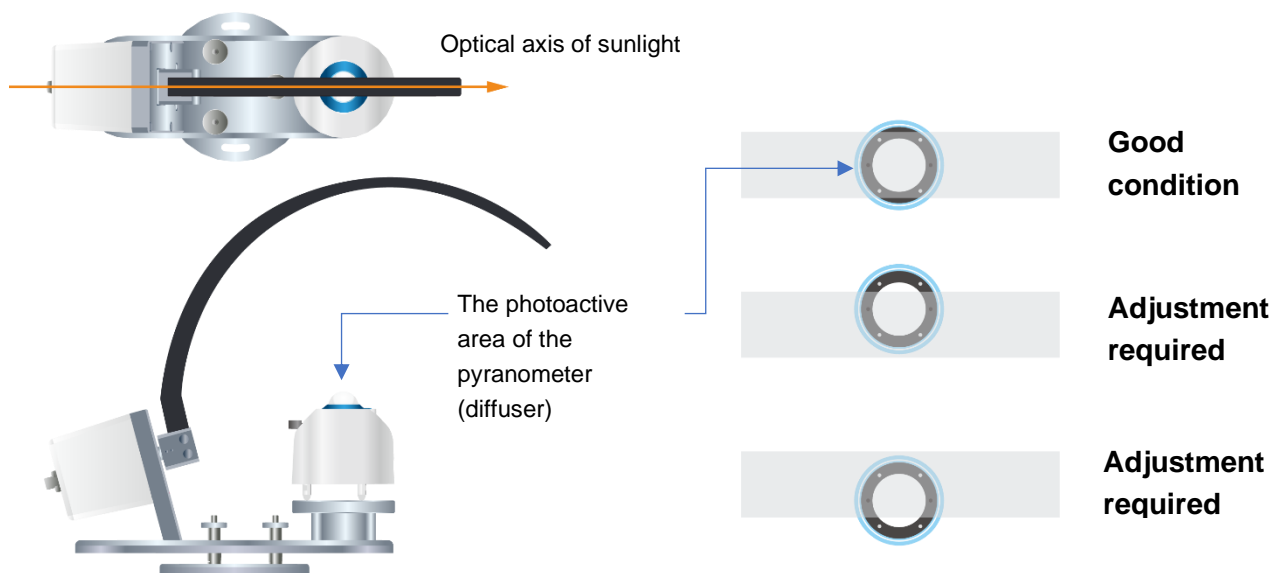

If the photosensitive area of the pyranometer (diffuser) is not completely shaded, loosen the RSB-02 fastening bolt as shown in the figure below, and adjust the installation orientation of the RSB-02 unit. It is best to perform this measurement as close as possible to solar noon.

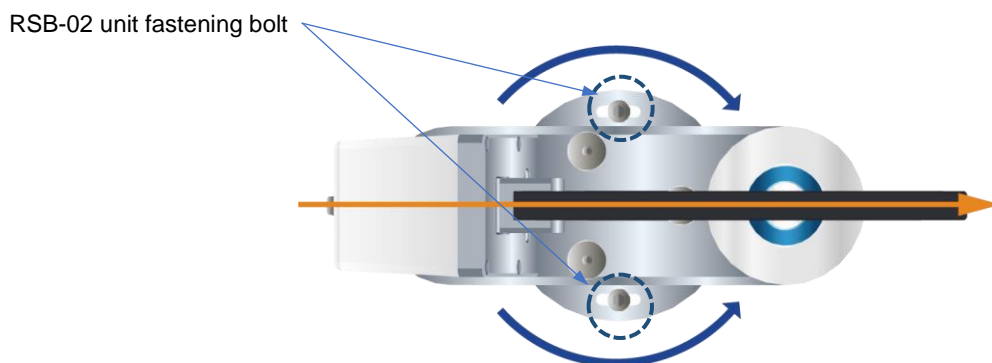

## 6-2 Measurement

To obtain the measured value, use the included Obi applications software, or read the values from the relevant registers by connecting the C-BOX to a datalogger or PLC device that can communicate via Modbus RTU (RS-485). Refer to Appendix A-2 for details about communication specifications. The registers that hold the measured values differ depending on the RSB-02 working mode and the system configuration (number of connected pyranometers). This relationship is made clear by the table below.

Address	Label	Description (*1)	RSB		TSB	
			1 Pyranometer	2 Pyranometers	1 Pyranometer	2 Pyranometers
7	GHI	GHI (x10) [Wm <sup>-2</sup> ]	○	○	–	○
22	PYR2_IRRAD	RSB MODE: RHI (x10) [Wm <sup>-2</sup> ] TSB MODE: GHI (x10) [Wm <sup>-2</sup> ]( <sup>*2</sup> )	–	○	–	○
48	PYR2_CALC	RSB MODE: Albedo (x1000) TSB MODE: DNI(x10) [Wm <sup>-2</sup> ]( <sup>*3</sup> )	–	○	–	○
8	DHI	DHI (x10) [Wm <sup>-2</sup> ]	○	○	○	○
9	DNI	DNI (x10) [Wm <sup>-2</sup> ]	○	○	–	○

\*1 The GHI, DHI, DNI, and RHI are multiplied by 10 and the resulting integers are read out. The measured values should be 1/10 of these figures. The albedo is multiplied by 1,000 and the resulting integer is read out. The measured values should be 1/1000 of these figures.

\*2 In TSB mode, the values of register 22 and register 7 will be the same.

\*3 In TSB mode, the values of register 48 and register 9 will be the same.

## 6-3 Change working mode

---

To change the working mode, use the included Obi application software (check Annex A-3), or enter the setting values into the appropriate registers by connecting the RS-485 (Modbus RTU) to the C-BOX. Refer to Appendix A-2 for details about communication specifications.

- TSB mode

The equipment is in TSB mode when shipped from the factory. Follow the steps below to switch from another working mode to TSB mode.

- 1 Set register 74 WORK\_MODE to 2**
- 2 Set register 64 UPDATE to 1**
- 3 Turn the system off and then on again**

- RSB mode

Follow the steps below to switch to RSB mode.

- 1 Set register 74 WORK\_MODE to 1**
- 2 Set register 64 UPDATE to 1**
- 3 Turn the system off and then on again**

# 7 Maintenance and Troubleshooting

## 7-1 Maintenance

Using the RSB-02 accurate results can be obtained if the glass dome of the pyranometer and the motion parts condition of the instrument are maintained properly. Regular maintenance and scheduled re-calibrations can also extend the lifetime of the pyranometer and instrument. However, environmental conditions, can have a deteriorating effect on the materials. Therefore, proper maintenance, adapted to the local environmental conditions, is required.

The following table describes the common maintenance tasks that should be performed on a regular basis:

### 7-1-1 Periodically Maintenance

#### Common Items

Frequency	Check Item	Method	Effect
Several times per week	Clean Glass Dome of the Pyranometer	Keep the glass dome clean by using demineralized water and wiping it with a soft cloth dry and clean.	The irradiance measurement will be affected due to a change in transmittance.
Weekly	Check Appearance Condition	Check for cracks and scratches on the glass dome of the pyranometer or shadow band plate.	Accurate measurements will not be possible.
	Check Spirit level	Verify if the pyranometer is leveled by checking the bubble is in the center ring of spirit level.	An additional cosine/azimuth error will be introduced.
	Check Sensor Installation Direction	Check the direction of RSB-02 main unit installation. Make sure it is facing towards the right direction.	Measurement errors due to misalignment of directional angles will occur.
	Check Cable Condition	Verify if the cable connector is properly connected, tightened to the connecting port, and how the cable is lined; make sure the cable is not shaking from the wind.	A disconnected cable will cause sporadic reading errors or failure of operation. If the cable is damaged, it may lead to noise or electric shock.
	Check Setup Base Condition	Check if the instrument is tightened properly to the mounting base plate and the base plate and/or table is securely fastened in a proper condition.	Loose instruments and/or mounting plates can lead to damages of the instruments and/or injury.

Frequency	Check Item	Method	Effect
Weekly, Before or After extreme Weather conditions	Check Sun- screen	Verify if the sun screen is securely fixed on the body, and the knurling screw is securely tightened.	This may lead to damaging the instrument and/or lead to increasing measurement error due to temperature increase by sun screen coming off.
	Check Shadow Band Plate	Verify if the shadow band plate is securely fixed on the shaft, and the screw is securely tightened.	This may lead to damaging the instrument and/or lead to increasing measurement error.

**Calibration check** (Advanced remote checks can be done on the MS-80S/SH)

Frequency	Maintenance Item	Method	Effect
Weekly	Data Validity	Check the daytime irradiance data and compare it to previous days or adjacent pyranometers.	When a large difference occurs operating problems or installation issues can be detected.
	Presence of Noise	Check night-time irradiance values	Night-time offsets and sensor stability issues can be revealed.
	Check the Temperature Inside	Check the inside temperature via RS485 (Modbus RTU) output.	If the inside temperature becomes abnormally high, the life of the product will be shortened.
	Check the Effect of Desiccant	Check the internal relative humidity alert status of the pyranometer via RS485 (Modbus RTU) output.	The condition of the drying agent can slightly change over time. If the relative humidity becomes high, the glass dome might be fogging up.
	Check the Tilt Angle	Check the tilt angle and roll angle via RS485 (Modbus RTU) output.	Any change in tilt position after the installation can affect the measurements due to the cosine response of the sensor.
Every 5 Years	Recalibration	To maintain the best possible measurement accuracy, recalibration of the pyranometer is recommended. Contact EKO for more details and requests for a recalibration and maintenance service.	Due to the natural aging of materials, the detector sensitivity of the pyranometer can gradually change over time.

## 7-1-2 Re-Calibration of RSB-02

It is recommended to recalibrate the instrument once every 2years. For further information about the calibration and recalibration, please contact EKO.

It is also recommended to recalibrate the MS-80S/SH once every 5 years in order to verify the good quality of the solar radiation measurements. For further information about recalibration and maintenance procedures, please contact EKO or find out more on the EKO website [eko-instruments.com].

EKO can offer calibration services for pyranometers and pyrhemometers in-house. Based on the applied calibration methods EKO provides the best quality solar sensor calibrations compliant with the international standards defined by ISO/IEC17025 / 9847 [Indoor method] and ISO9059 [Outdoor method] [Certification: L13-94-R2 /

[www.pjlabs.com](http://www.pjlabs.com)]

## 7-2 Troubleshooting

Read the following items in case of trouble with the instrument. If any questions should remain, please contact EKO for further technical support.

### Troubleshooting in field

Failure	Action
No output.	<p>Make sure that the sensor or main unit is properly connected to the control box, and type of power supply and voltage values are appropriate.</p> <p>Also check the communication settings [i.e., port, baud rate, converter ID] are appropriate.</p>
Output value is too low	<p>The glass dome maybe soiled with rain or dust. Clean the glass dome with demineralized water and soft cloth.</p> <p>The output may decrease over time. Recalibrate periodically.</p>
Negative output signal during night-time.	<p>Pyranometers generate an output signal, which is proportional to the temperature differences between the sensor's so-called hot and cold junctions. Night-time offset can occur when the dome temperature will cool down below the temperature of the detector. A slight negative offset within the specification can be expected.</p>
Unusual noise	<p>Make sure that the shadow band does not rattle, and that the mounting screws for the RSB-02 unit, C-BOX, and the pyranometer are not loose.</p> <p>Check the shield connection and make sure it is connected securely.</p> <p>Make sure if the output cable is not shaking from the wind; take necessary measure by fixing or lining the cables through a metal pipe.</p> <p>Check for any objects, which emit electromagnetic wave around the instrument and or the cable.</p>

# 8 Specification

## 8-1 RSB-02 Main Unit

### RSB-02 Main Unit specifications

Characteristics	Details	Remarks
Power Supply Voltage Range	12 to 24Vdc (*1)	Supplied via C-BOX
Power Supply Current	0.5A	
Power Consumption	< 6W	
Digital I/O Signal	RS-485 Communication	
Communication Protocol	Modbus RTU	
Measurement Interval	15sec	In RSB mode
	1sec	In TSB mode
Operating Temperature	-20°C to +70°C	
Dimensions	140.0mm(W)×388.5mm(D)×320.0mm(H)	When the shadow band is standing 90°
Weight	3.5kg	Without Pyranometer
Materials	Body : A6063BD	
	Band : PET	
Ingress Protection	IP65	
Cable	5-core shielded cable 1.5m	M12, angled - M12, straight
Warranty Terms	2 years	

(\*1) Note that the lower limit of the voltage range is DC12V-0% and the upper limit of the voltage range is DC24V+10%.

案: Note that this product requires a power supply voltage from 12VDC (no lower tolerance) up to 24VDC (+10% tolerance).

## 8-2 C-BOX

### C-BOX specifications

Characteristics	Details	Remarks
Power Supply Voltage Range	12 to 24Vdc <sup>(*1)</sup>	
Power Supply Current	0.3A	
Power Consumption	< 3.6W	
Digital I/O Signal	RS-485 Communication	
Communication Protocol	Modbus RTU	
Connection Devices	RSB-02 Main Unit	
	MS-80S/SH Pyranometer	
	GPS Module (Built-In)	
Output Data	Irradiance : DNI/GHI/DHI	
	Meta data : T, RH, Tilt, Time, Long/Lat/Solar Position	
Measurement Mode	1. RSB Mode	Selectable
	2. TSB Mode	
Irradiance Range DHI (Measured)	0 -2,000W/m <sup>2</sup>	MS-80S/SH Specification
Irradiance Range GHI (Measured)	0 -2,000W/m <sup>2</sup>	MS-80S/SH Specification
Irradiance Range DNI (Calculated)	0 -2,000W/m <sup>2</sup>	
Operating Temperature	-20°C to +70°C	
Dimensions	170.0mm(W) ×113.1mm(D)×61.0mm(H)	
Weight	1.2kg	
Materials	Body : A6063BD	
Ingress protection	IP65	
Cable	5-core shielded cable 10m Standard:10m, Option <sup>(*2)</sup> : 20m, 30m	M12, straight - TAB terminal
Warranty terms	2 years	

(\*1) Note that the lower limit of the voltage range is DC12V-0% and the upper limit of the voltage range is DC24V+10%.

案: Note that this product requires a power supply voltage from 12VDC (no lower tolerance) up to 24VDC (+10% tolerance).

(\*2) When using the optional cable (20m or 30m), be sure to set a power supply voltage to 24VDC

## 8-3 Pyranometer (MS-80S/SH)

### Pyranometer specifications

Characteristics		Details	Remarks
ISO 9060:2018		Class A (Fast response and Spectrally flat)	
Response time	95%	< 0.5 sec	
	99%	< 1 sec	
Zero offset A		$\pm 1 \text{ W/m}^2$	Thermal Radiation ( $200 \text{ W/m}^2$ )
Zero offset B		$\pm 1 \text{ W/m}^2$	Temperature change (5K/h)
Zero offset C		$\pm 2 \text{ W/m}^2$	Total zero off-set
Non-stability		$\pm 0.5 \text{ \%}/5\text{years}$	
Non-linearity		$\pm 0.2 \text{ \%}$	
Directional response		$\pm 10 \text{ W/m}^2$	
Spectral error		$\pm 0.2 \text{ \%}$	
Spectral selectivity		$\pm 3 \text{ \%}$	
Temperature response	-10°C to +40°C	$\pm 0.5 \text{ \%}$	
	-20°C to +50°C	$\pm 0.5 \text{ \%}$	
	-40°C to +70°C	$\pm 2 \text{ \%}$	
Tilt response		$\pm 0.2 \text{ \%}$	
Additional signal processing error		$\pm 1 \text{ W/m}^2$	

## Other Specification

Characteristics		Details	Remarks
Field of view		$2\pi$ [sr]	
Wavelength range		285 to 3,000nm	
Temperature range <sup>[1]</sup>	Operating	-40°C to +80°C	
	Accuracy guaranteed	-20°C to +50°C	
Maximum irradiance <sup>[2]</sup>		4,000W/m <sup>2</sup>	
Digital signal output		-200W/m <sup>2</sup> to +2000W/m <sup>2</sup>	
Spirit level accuracy		0.1°	
Tilt sensor accuracy		<±1°	
Humidity sensor accuracy		±2%RH	Nominal value
Temperature sensor of PCB		±0.5degC	Nominal value
Detector temperature sensor		Pt100 Class A <sup>[3]</sup>	
Internal temperature sensor		±0.5degC	
Ingress protection		IP 67	
Dimensions		Width:φ96mm, Overall height:Approx.101mm	Including sun screen
Weight		0.41kg	
Sensitivity		Approx.10μV/W·m <sup>-2</sup>	
Cable		5-core shielded cable 1.5m	M12, straight - M12, straight
Communication with C-BOX		Modbus RTU via RS-485	
Power supply		12Vdc to 24Vdc	Supplied via C-BOX
Power consumption	MS-80S	< 0.2W	
	MS-80SH	< 1.4W	With heater function ON

[1] When the instrument is used in the ambient temperature exceeding the accuracy assurance temperature range, the measurement error may increase.

[2] The operational maximum irradiance is defined as the maximum irradiance exposure level. Beyond this point damage may occur to the sensor.

[3] A temperature sensor is internally connected to Modbus electronics.

# 8-4 Dimensions

## Main unit

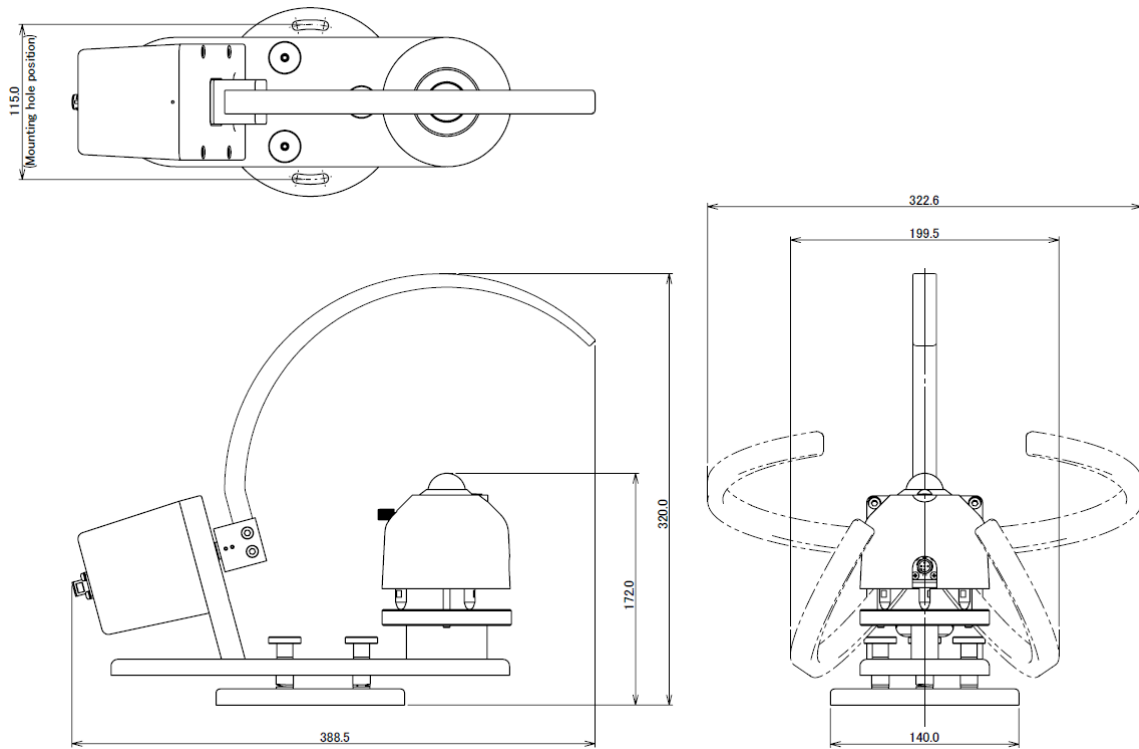

Figure 8-4-1. Dimensions of Rotating Shadow Band Main Unit

## C-BOX

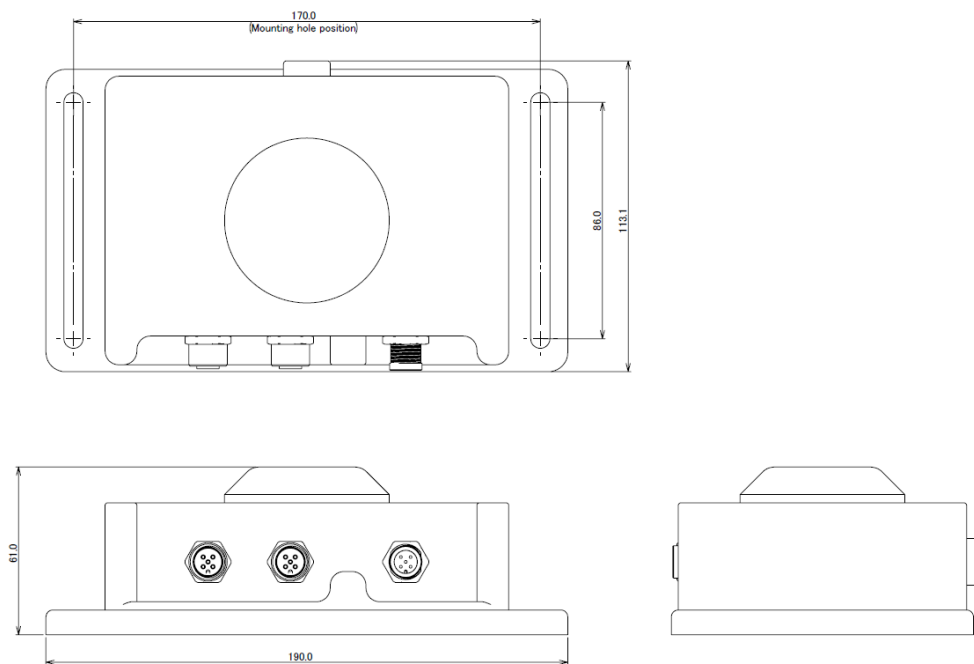

Figure 8-4-2. Dimensions of C-BOX

**Pyranometer (MS-80S/SH)**

## Dimensions

	MS-80S/SH
A. Fixing Hole Pitch	65mm
B. Body Height	73mm
C. Levelling Screw Height	16mm
D. Width [including Sun screen/Cover]	Φ96mm
E. Overall Height [approx.]	101mm

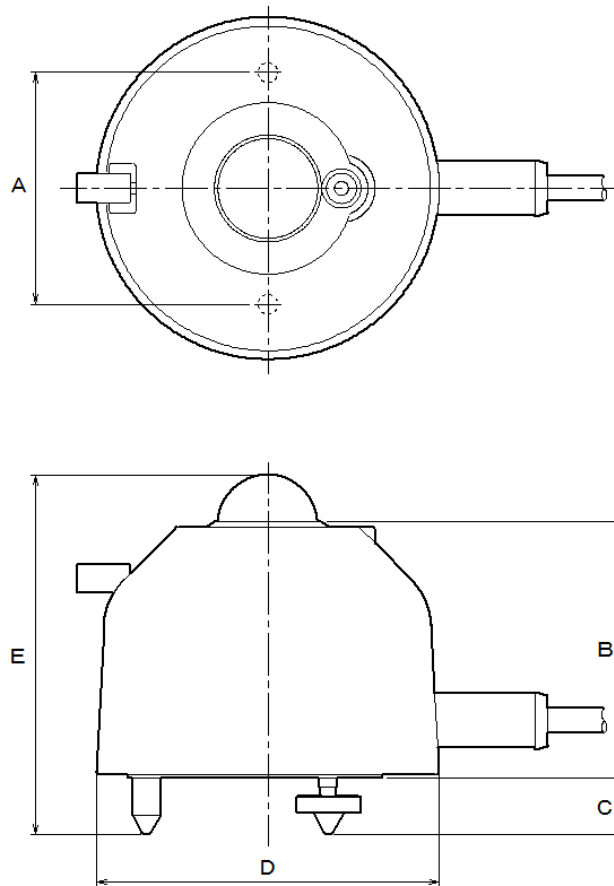
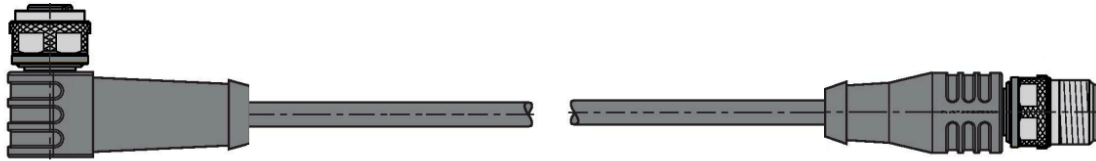

Figure 8-4-3. Dimensions of pyranometer (MS-80S/SH)

## 8-5 Cable

Female M12, angled ⇔ Male M12, straight (1.5m)



Female M12, straight ⇔ Male M12, straight (1.5m)



Male M12, straight (Standard: 10m, Option: 20m, 30m)

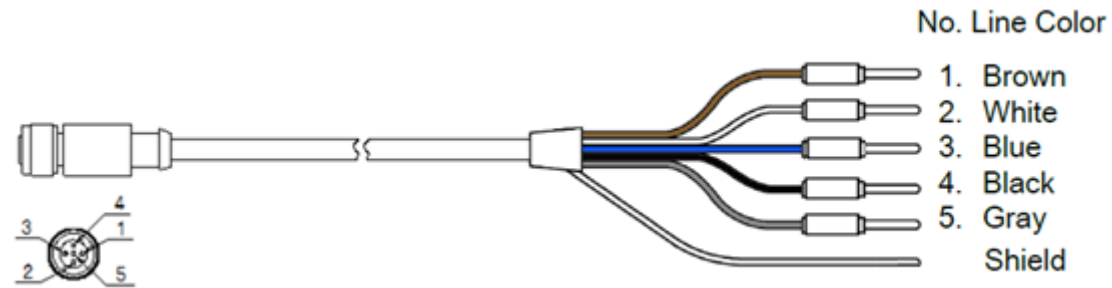

## 8-6 Accessories List

The following optional accessories are available for RSB-02 and MS-80SH Plus+ systems.

Please contact us for more information.

Item	Remarks
USB to RS485 Converter cable	Used for communication between control unit (C-BOX) and PC
T Splitter Connector	Used to connect an optional pyranometer
Signal Cable for Pyranometer	Used to connect an optional pyranometer
Signal Cable for C-Box	Used when a cable length of 10m or more is required (With cable length of 20m or 30m, Male M12, straight connector <sup>(*)</sup> )

(\*1) When using the optional cable (20m or 30m), be sure to set a power supply voltage to 24VDC

# APPENDIX

## A-1. Radiometric Terms

### Definitions of Terms

Global Solar Irradiance, Global Horizontal Irradiance [GHI]	Hemispherical solar irradiance received by a horizontal plane surface, expressed in units of W/m <sup>2</sup> or kW/m <sup>2</sup> .
Direct Solar Irradiance, Direct Normal Irradiance [DNI]	Normal-incidence solar irradiance received over a small solid angle which includes the circumsolar irradiance, expressed in units of W/m <sup>2</sup> or kW/m <sup>2</sup> .
Diffuse Solar Irradiance, Diffuse Horizontal Irradiance [DHI]	Global horizontal irradiance without the direct solar irradiance, i.e., indirect irradiance of the scattered solar radiation [by air molecules, aerosol particles, clouds, etc.], expressed in units of W/m <sup>2</sup> or kW/m <sup>2</sup> .
Pyranometer	A radiometer designed to measure the hemispheric solar irradiance over the wavelength range of about 300 to 3,000nm.
Pyrheliometer	A radiometer is designed to measure the direct solar irradiance over a certain solid angle including the circumsolar irradiance.
World Meteorological Organization (WMO)	It is a specialized organization of the international union that carries out international standardization and coordination of meteorological work. WMO: Abbreviation for World Meteorological Organization
World Radiation Reference [WRR]	Radiometric reference instrument system which has an uncertainty of less than +/-0.3%, expressed in SI units. This reference is maintained by the World Meteorological Organization [WMO], and it has been issued since January 1, 1980 WRR: World Radiation Reference
ISO9060:2018	An ISO norm [International Standard]. The first edition was published in 1990, then the second edition was revised in 2018. Based on the performance of each characteristic, the Pyranometer is classified into three classes A, B, and C, and specifications of 'Spectrally flat radiometer' and 'Fast response radiometer' are set as sub-categories. Pyrheliometer is classified into 4 classes of AA, A, B and C based on the performance of each characteristic, and specifications of 'spectrally flat radiometer' and 'Fast response radiometer' are set as sub-categories.

## A-2. Communication specifications

At the factory, the specification for communication between the RSB-02 and C-BOX is set as follows. In order to connect a pyranometer, the address of the pyranometer must be entered into the C-BOX.

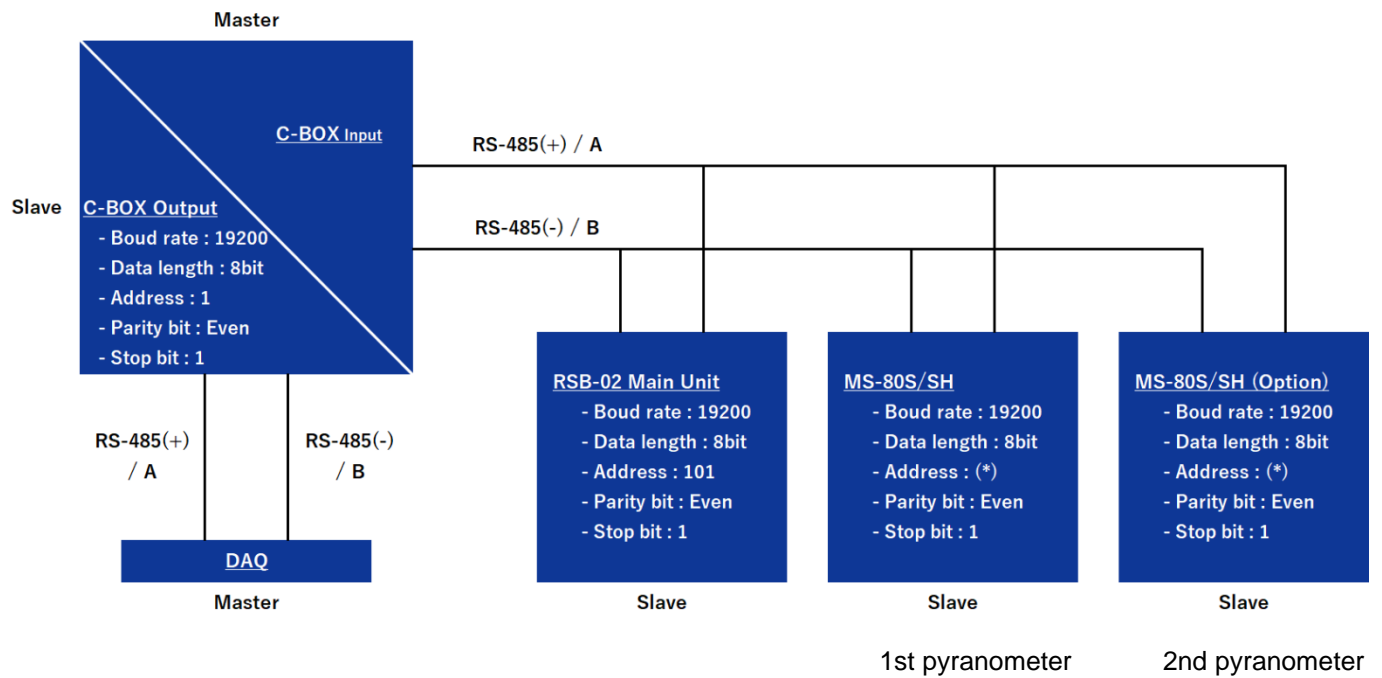

\* Last two digits of its pyranometer product serial number. "100" if the last two digits are "00".

### A-2-1. C-BOX Communication Specification (Summary)

This device supports RS485 (Modbus RTU). ASCII mode is not supported.

The communication specification is as follows.

**Table A-2-1. C-BOX Communication Specification**

Item	Remarks
Electrical specification	EIA-485
Connection form	Multi-drop method (*1)
Communication protocol	Modbus RTU (*2)(Slave)
Communication speed (baud rate)	9600 /19200 /38400 /57600 /115200 bps
Data length	8 bit
Stop bit	1 bit / 2bit
Parity bit	None /Even /Odd
Transmission distance	10m (using included cable)
Error detection system	CRC-16

\*1: We recommend a one-to-one connection between the data logger and the C-box. When connecting multiple C-boxes, set the system power supply voltage to 24 V DC.

\*2: This is an open protocol for serial communication developed by Modicon.

### A-2-2. C-BOX communication specification (Function codes)

Data is read and written to the holding Register.

**Table A2-2. Supported function codes**

Function Code (Hexadecimal)	Function
0x03	Read Holding Registers
0x10	Write Multiple Registers

### A-2-3. C-BOX communication specifications (Data format)

**Table A2-3. Data formats used**

16bit	Abstract
U16	Unsigned 16-bit Integer
S16	Signed 16-bit Integer
U32	Unsigned 32-bit Integer

The communication byte order of communication is big endian. 2-byte values are sent in H-byte → L-byte order, 4-byte values are sent in H-word → L-word order. The table below shows how each format is allocated.

**Table A2-4. Assignment of 8/16/32-bit values**

8-bit	0x12	0x34	0x56	0x78
16-bit	0x1234 (MSW)		0x5678 (LSW)	
32-bit	0x12345678			

The word order for 32-bit registers is low word (LSW) first, followed by high word (MSW).

The table below shows when 0x12345678 can be assigned to address “n” of the Modbus registers.

**Table A2-5. Relationship between 32-bit values and Modbus registers.**

32-bit	0x12345678
Modbus register (address n)	0x5678 (LSW)
Modbus register (address n+1)	0x1234 (MSW)

## A-2-4. C-BOX Communication Specifications (Register map)

This device is for use only with holding registers.

**Table A2-6. Holding registers**

Address	Label	R/W	Format	Description
0	FW_VERSION	R	U16	Firmware version
1	SERIAL	R	U16	Last 4 digits of serial number
3	STATUS_FLAGS	R	U16	Bitwise flags : RESERVED           0x1 NO_GPS             0x2 RESERVED           0x4 RESERVED           0x8 NO MOTOR           0x16
4	ACTIVE_MODE	R	U16	ACTIVE mode: 0: STARTUP mode 1: RSB mode 2: TSB mode
5	TIMESTAMP	R	U32	Timestamp from GPS : Low
6				Timestamp from GPS : High
7	GHI	R	S16	MS-80S/SH 1st GHI (W/m <sup>2</sup> ) (x10)
8	DHI	R	S16	MS-80S/SH 1st DHI (W/m <sup>2</sup> ) (x10)
9	DNI	R	S16	MS-80S/SH 1st DNI (W/m <sup>2</sup> ) (x10)
17	PYR1_READING	R	S16	MS-80S/SH 1st Irradiance direct output (W/m <sup>2</sup> ) (x10)
18	PYR1_TEMP	R	S16	MS-80S/SH 1st Temperature (degree C°) (x10)
19	PYR1_TILT_X	R	S16	MS-80S/SH 1st Tilt X (degree °) (x10)
20	PYR1_TILT_Y	R	S16	MS-80S/SH 1st Tilt Y (degree °) (x10)
21	PYR1_RH	R	U16	MS-80S/SH 1st Relative Humidity (%RH) (x10)
22	PYR2_IRRAD	R	S16	MS-80S/SH 2nd Irradiance (W/m <sup>2</sup> ) (x10)
23	PYR2_TEMP	R	S16	MS-80S/SH 2nd Temperature (degree C°) (x10)
24	PYR2_TILT_X	R	S16	MS-80S/SH 2nd Tilt X(degree °) (x10)
25	PYR2_TILT_Y	R	S16	MS-80S/SH 2nd Tilt Y (degree °) (x10)
26	PYR2_RH	R	S16	MS-80S/SH 2nd Relative Humidity (%RH) (x10)
27	GPS_SATS	R	U16	Amount of visible GPS satellites
30	LAT	R	S16	Latitude (x100)
31	LON	R	S16	Longitude (x100)
32	ELEVATION	R	S16	Sun elevation (degree °) (x100)
33	AZIMUTH	R	S16	Sun azimuth (degree °) (x100)
44	SUN_RISE	R	U32	Calculated Sunrise time stamp : Low
45				Calculated Sunrise time stamp : High

Address	Label	R/W	Format	Description
46	SUN_SET	R	U32	Calculated Sunset time stamp : Low
47				Calculated Sunset time stamp : High
48	PYR2_CALC	R	S16	Data when using MS-80S/SH 2nd; RSB mode: Albedo (RHI/GHI) (x1000) TSB mode: DNI (W/m2) (x10)
64	UPDATE	R/W	U16	Set to 1 to store settings in EEPROM.
69	GHI_NODE_ADDR	R/W	U16	Node number of the MS-80S/SH 1st
70	EXT_SENSOR	R/W	U16	Sensor type of the 2nd pyranometer; 0: Disconnected 3: MS-80S/SH
71	EXT_NODE_ADDR	R/W	U16	Node number of the MS-80S/SH 2nd
72	PYR2_ENABLED	R/W	U16	Activation of the 2nd pyranometer; 0: Disable 1: Anable
74	WORK_MODE	R/W	U16	This register sets the operation mode for the next startup. Set the following value to this register and set 1 to register No.64 "UPDATE". The operation mode of the device can be changed by power cycle. 1: RSB mode 2: TSB mode

## A-3. Software (Obi)

### A-3-1. About our Software

“Obi” is derived from the Japanese word for “band” in reference to the shadow band. This software allows you to visualize the detection data, save the data, set communications parameters, and detect and troubleshoot errors while using the MS-80S/SH.

To use the software, you will need to download it to a PC from the EKO website (MS-80SH Plus+ product page), and then connect that PC to the C-BOX with RS-485/USB converter.

### A-3-2. Software Installation

#### System requirements

Item	Requirements
PC	A personal computer running Windows® CPU: 2 GHz or more Memory requirement: 4 GB or more recommended
Free space on hard drive	300 MB or more
Display	Resolution: 1024x768 or more
OS	Microsoft® Windows®11 Home Microsoft® Windows®11 Pro Microsoft® Windows®10 Home Microsoft® Windows®10 Pro
Communications interface	USB port (Ver. 2.0 or higher)



- This product may not operate properly if the above requirements are not met.
- This product will not run on Windows® 8.1 or earlier.
- Administrator privileges are required to operate this software.

## 1 Download “Obi” to your PC

Download the latest version of the file “Obi.zip” from the MS-80SH Plus+ product page on the EKO website.

## 2 Install “Obi” on your PC

Once you unzip the file Obi.zip, you will see the file Obi.exe.

Run this file to install the “Obi” software.

- ① During installation, a screen will be shown asking whether you want to create a desktop icon. Check the box if you want to create an icon, then click [Next].

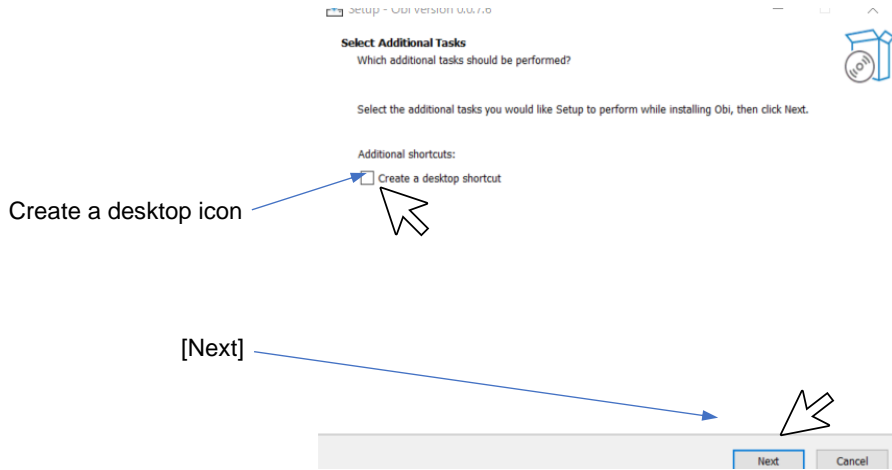

- ② Once you see the installation complete screen, click [Finish] to show the “Obi” Start screen.

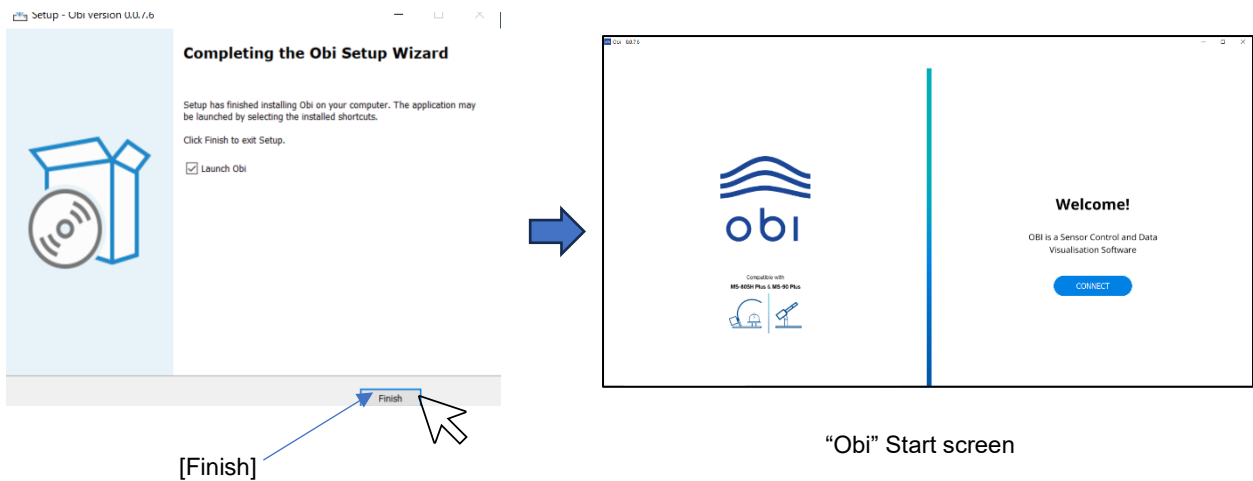

### A-3-3. Connect PC to the system

Connect the C-BOX to the PC to connect to the system. See “5. Installation” for details about the system-side connection (connection between MS-80S/SH, RSB-02 and C-BOX).

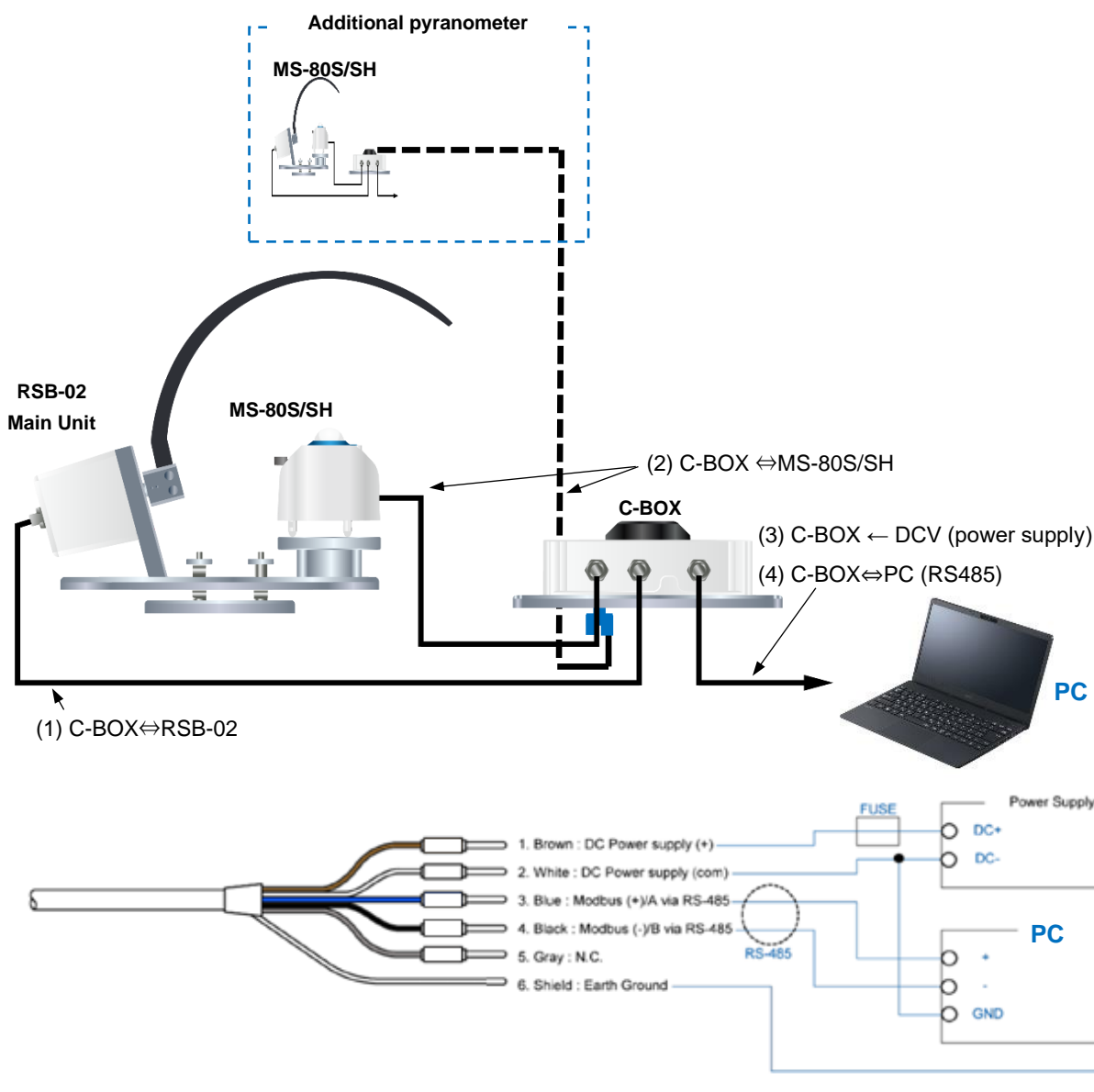

## 1 Supply power to C-BOX

Once you supply power to the C-BOX, the system will start up and the shadow band will automatically move to the 90° position. After that, it will begin to acquire GPS position information.



Once power is supplied to the C-BOX, the RSB-02 will automatically swivel to the start position (90°). Be careful not to touch the shadow band as this could result in injury or damage to the equipment. After position information has been acquired from GPS satellites, the equipment is ready to start measurements (You can check the data acquired from the satellite after Obi is connected).

## A-3-4. Automatic system registration

Register “Obi” in the system.

### 1 Start “Obi”

Click [Connect] on the Start screen to show the New Instrument (New registration) screen.

#### Start screen

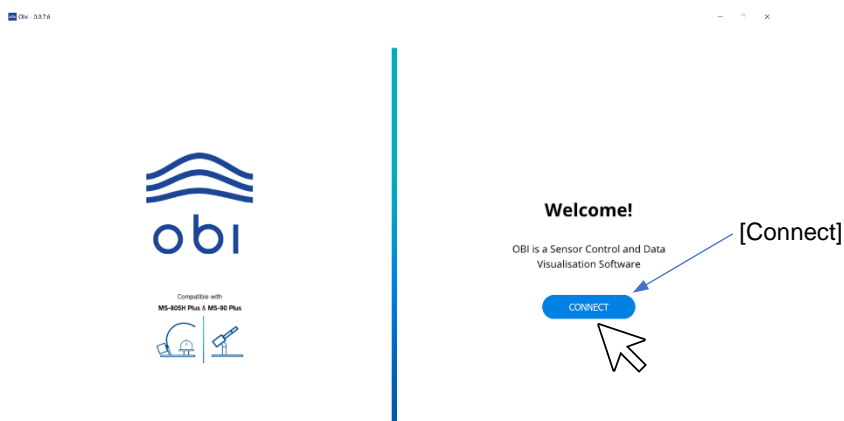

### 2 Register the device

Use the “Auto-connect” function to automatically link “Obi” to the C-BOX.

Click [Auto Detect] on the New Instrument (New registration) screen.

#### New Instrument (New registration) Screen

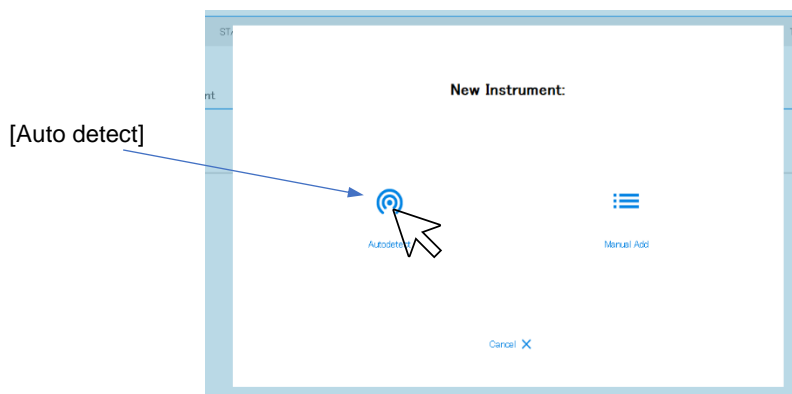

### 3 Save the connection

If the connection is successful, the connected device (device name and illustration) will be shown. Click [Save] to save the configuration data.

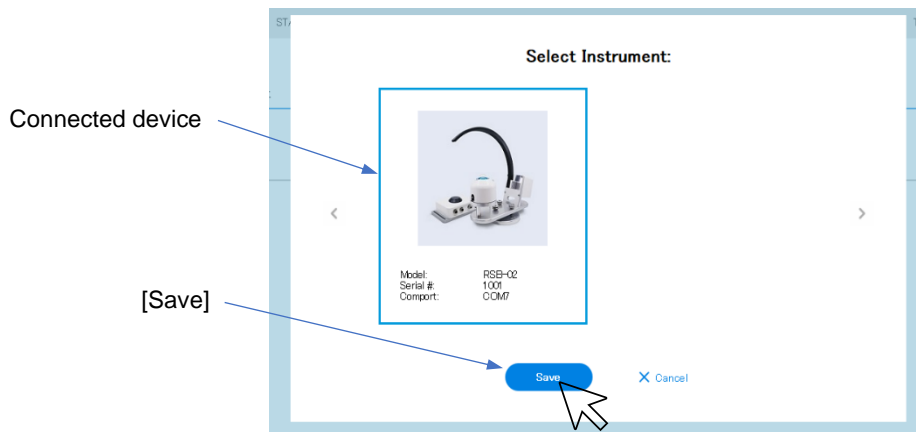

**⚠** If you are not able to move from Step 2 to Step 3, and an "Unable to connect" message is shown, you may not be able to connect automatically. In this case, you will need to connect manually. (→Pg. 53 "A-3-5 Register system manually")

### 4 Display the Measurement screen

As soon as you save the connection, communication will be established with the device and a tree view screen like the one below will appear showing "Dashboard" (measurement screen), "RSB-02" (device name), and "Add New System" (add connection). On this screen, select "RSB-02".

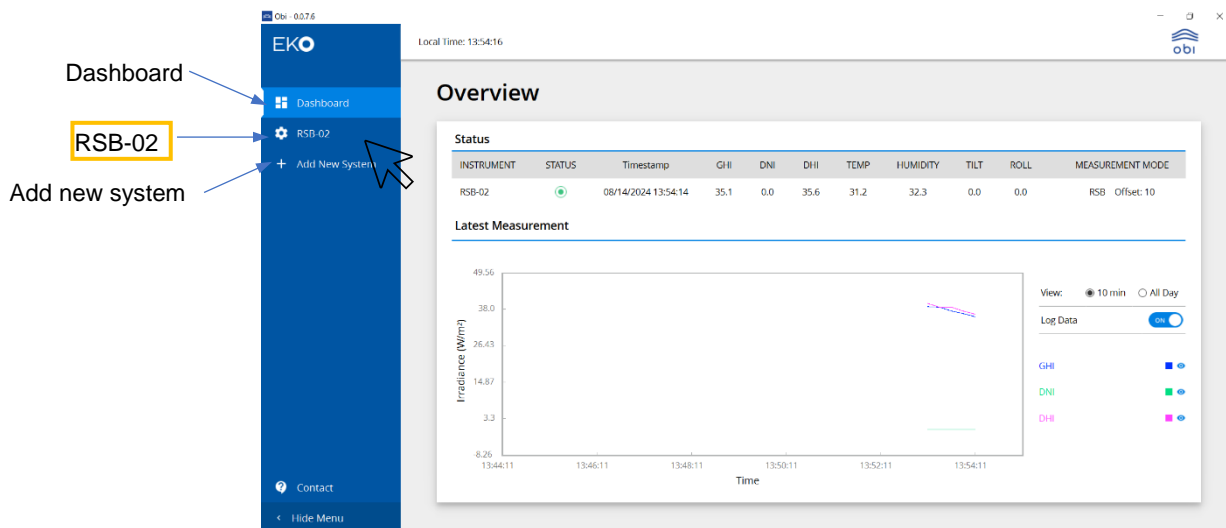

## 5 Check connection status

The MS-80SH Plus connection status will be shown. Confirm that the normal indication is shown for items ① through ④.

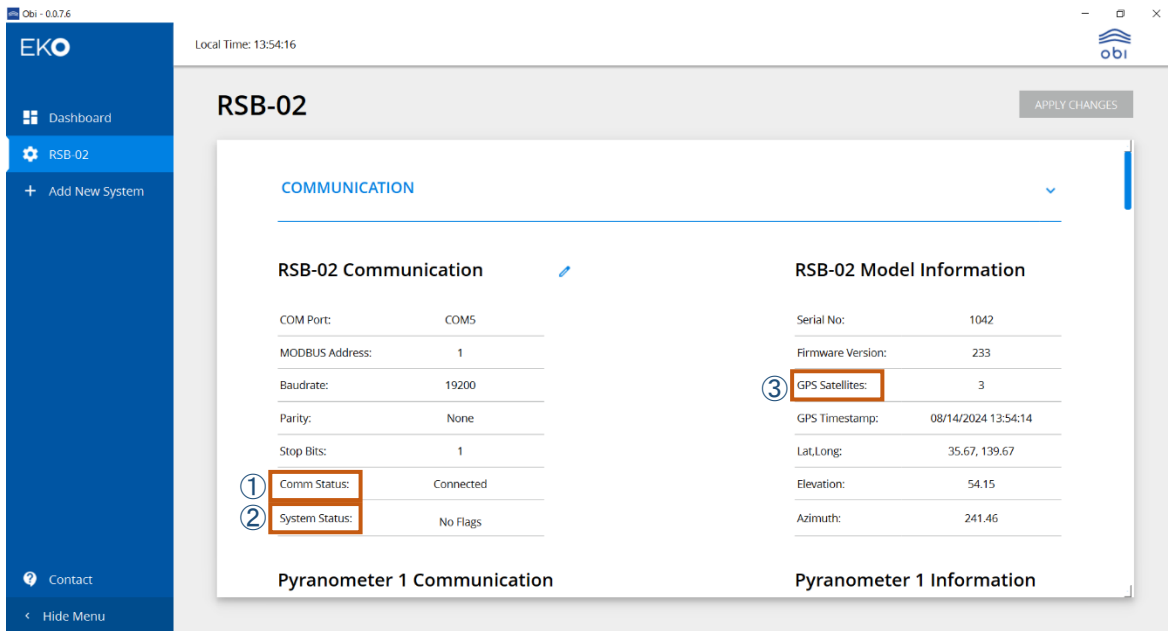

NO	Display	Details	Normal Indication	Abnormal Indication	How to deal with abnormal indication
①	Comm Status	Status of communication with RSB-02	Connected	Disconnected	With the software in the startup state, turn the power to the RSB-02 off and then on again.
②	System Status	GPS supplementation status	No Flags	No GPS	Move the C-Box to a position in which it can be supplemented by GPS
③	GPS Satellites	Number of supplementary GPS signals	3 or more	2 or less	
④	Connection Status	Status of communication with RS-80S/SH	Connected	Disconnected	With the software in the startup state, turn the power to the MS-80S/SH off and then on again.

The connection is now complete

### A-3-5. Register system manually

Take the following action if you cannot connect using “2-3 Automatic system registration”.

- If you see the message “No instruments were detected”:

The device may not be turned on, or not properly connected. Check the wiring and the main power supply.

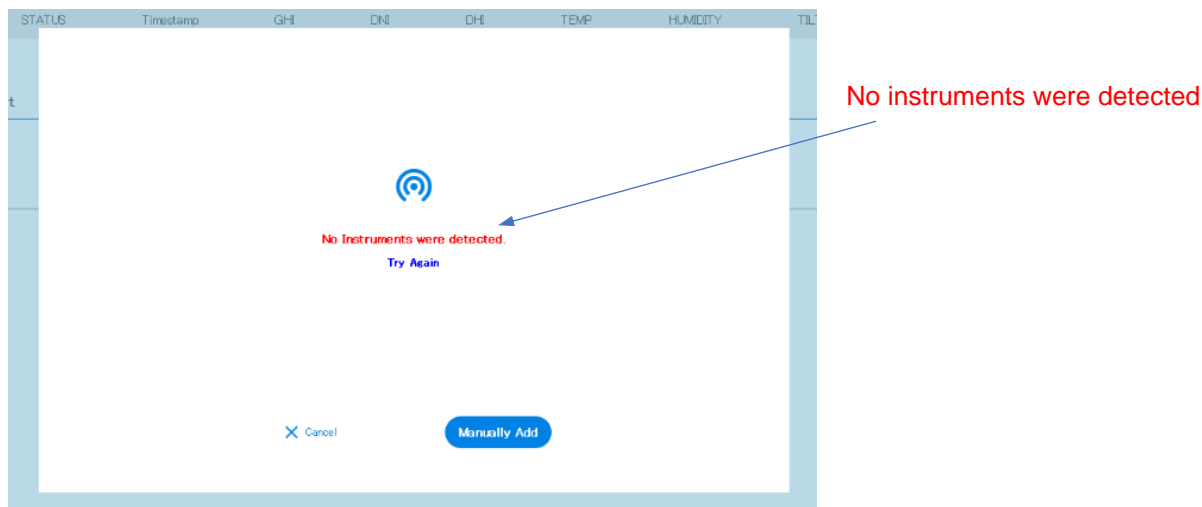

If the screen shows “No instruments were detected”, even though the system is turned on and the wiring is correct, the problem may be that the PC does not recognize the COM port because the RS-485 to USB converter driver software is not installed. Check the Windows Device Manager to see whether the port had been recognized and assigned a COM number. If it has not, you will need to install the driver software from the supplier of your RS-485 to USB converter.

- If the screen shows “Connecting your sensor, please reconnect your sensor within 10 seconds.”:

The device may not be properly connected. If this happens, perform manual configuration to configure the device connection settings individually and recognize the device (Steps 1 to 3 below).



# 1 Enter the connection parameters

Click [Try Again] to return to the New Instrument (New registration) screen, then click [Manual Add].

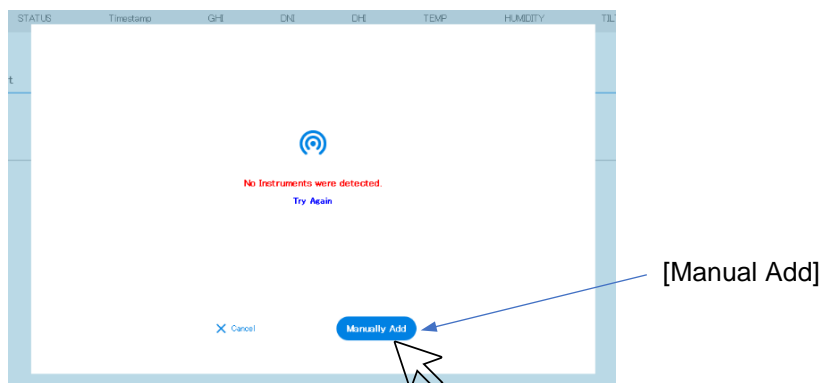

The “Manual Configuration Screen” will be shown.

When the connection configuration screen appears, enter the communication parameters and click [Add instruments].

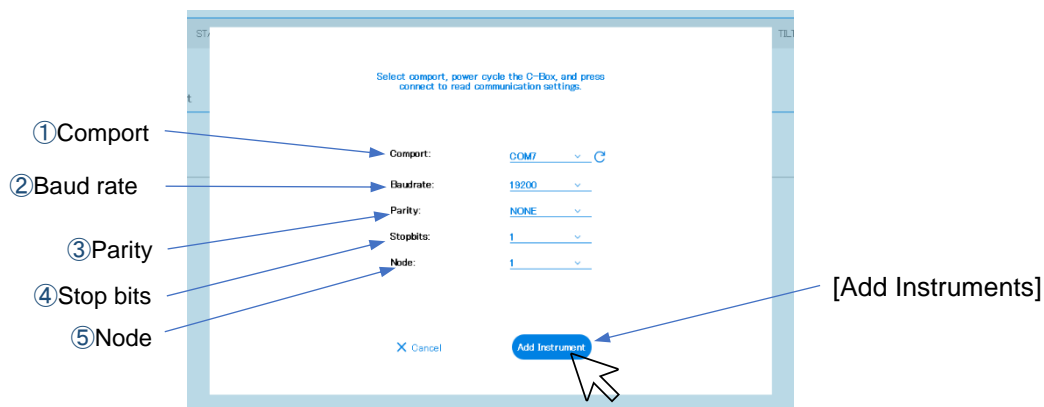

NO	Display	Explanation	Selectable Values	Default	Entry
①	Comport	COM port number	COM1, etc.	—	Selected port numbers (*)
②	Baud rate	Communication speed	9600, 19200, 38400 57600, 115200	19200	Select 19200
③	Parity	Parity check value	NONE, EVEN, ODD	Even	Select Even
④	Stop bits	Value that indicates the end of the signal	1, 2	1	Select 1
⑤	Node	Node Address	1 to 100	1	Select 1

\* Check Windows Device Manager for the connected port

## 2 Save the connection

As with automatic connection, if the connection is successful, an illustration will be shown indicating that the device (device name and illustration) was recognized. Click [Save] to save the connection data.

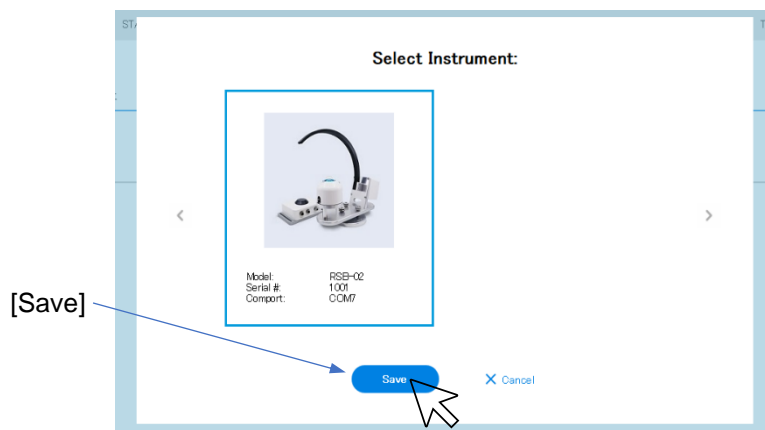

After that, follow steps 4 and 5 in “A-3-4 Automatic system registration” on page 50.

### A-3-6. Pyranometer Address Configuration

After setting up the system connection, follow the steps below to connect to the PC.

#### 1 Connect the C-BOX and PC

With the C-BOX turned off, check the connection of the communication cable between the PC and C-BOX (RS-485 ⇒ USB).

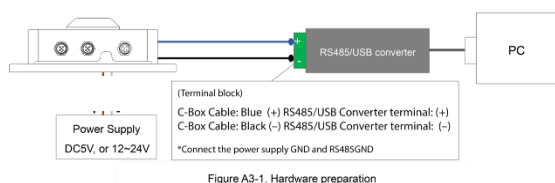

#### 2 Supply power to the C-BOX

Power will be supplied to the RSB-02 and MS-80S/SH, and the shadow band will operate.

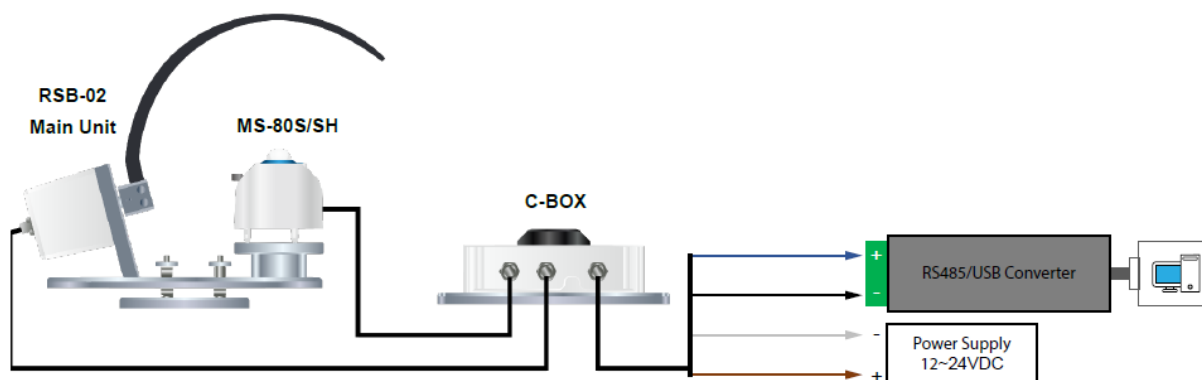

### 3 Start Obi

After you start Obi on your PC, the start screen will appear. Click [Connect].

#### Start screen



### 4 Display the Dashboard

If the connected device matches one of the saved devices in the connection settings, the Dashboard will be shown immediately.

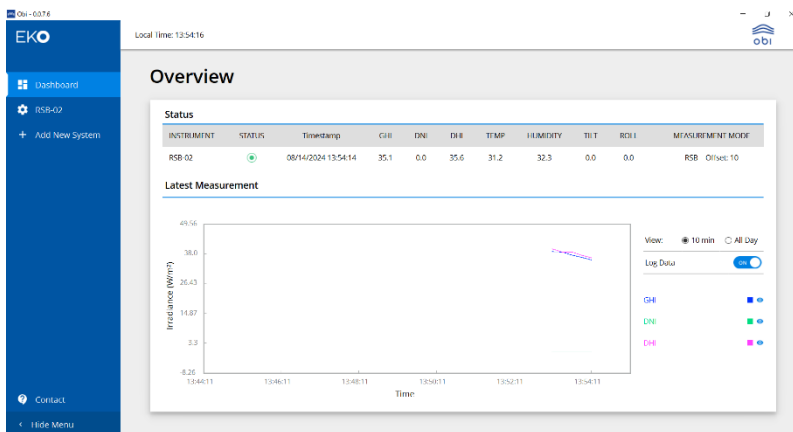

The connection settings can store data for multiple devices. If a connected device matches the saved data, its information is shown automatically. It is also possible to show multiple MS-80S/SH connections (optional). However, only one RSB-02 main unit can be shown.

### 5 Configure the pyranometer address

Set the address of the pyranometer to the last two digits of its serial number. (See “A-3-7. Screen operation and display” on page 57 for more details about the configuration procedure.)

### A-3-7. Screen operation and display

Selecting “ RSB-02” from the tree view on the left side of the screen [A] will show the initial “Communication” screen which displays device information and connection status.

Selecting [B] from the drop-down menu allows you to select [Communication] → [Measurement Mode], [Installation Mode], [Demo Mode], [Manual GPS Mode], [Calibration Mode], and [Data Mode]. See the following for information on the indications and configuration details for each.

#### Communication screen

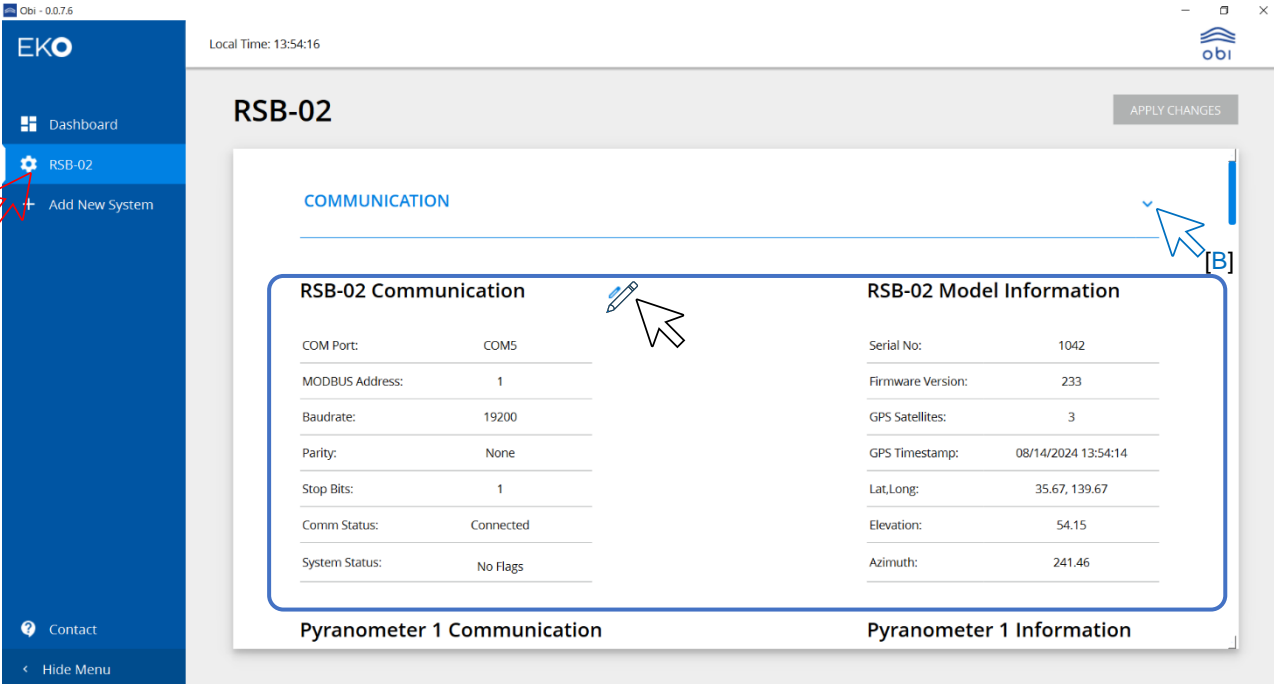

The screenshot shows the 'Communication screen' for 'RSB-02'. The left sidebar [A] contains the navigation menu with 'RSB-02' selected. The main area [B] displays the 'COMMUNICATION' screen. It features two panels: 'RSB-02 Communication' and 'RSB-02 Model Information'. The 'RSB-02 Communication' panel includes a pencil icon next to its title, indicating it can be edited. The 'RSB-02 Model Information' panel includes a dropdown arrow next to its title, indicating it can be expanded to show more options.

RSB-02 Communication		RSB-02 Model Information	
COM Port:	COM5	Serial No:	1042
MODBUS Address:	1	Firmware Version:	233
Baudrate:	19200	GPS Satellites:	3
Parity:	None	GPS Timestamp:	08/14/2024 13:54:14
Stop Bits:	1	Lat,Long:	35.67, 139.67
Comm Status:	Connected	Elevation:	54.15
System Status:	No Flags	Azimuth:	241.46

The following items marked with ‘○’ can be changed by setting values by selecting the pencil mark  next to the title.

#### <RSB-02 Communication>

- COM Port                      Setting the communication port number.  
Select a valid COM port number from the pull-down list.
- MODBUS Address              Setting the Modbus communication address.  
Select the Modbus address of the C-Box from the pull-down list.  
[List] 1 - 100 (Default value = 1)
- Baud rate                        Setting the Modbus Communication Speed.  
Select the Modbus communication speed from the pull-down list.  
[List] 9600, 19200, 38400, 57600, 115200 (Default value = 9600)
- Parity                            Setting the Modbus communication parity bit.  
Select the Modbus communication parity bit from the pull-down list.  
[List] None, Even, Odd (Default value = None)
- Stop Bits                        Indicating the Modbus communication stop bit.  
Select the Modbus communication stop bit from the pull-down list.  
[List] 1, 2 (Default value = 1)





### <Pyranometer 2 Communication>

- Node                      Setting of the Modbus address of the pyranometer (Pyranometer 2) for optional measurement.  
Enter the last two digits of the pyranometer serial number to be used.  
[Input range] 1 to 100 (Default value = 3)
  
- Connection Status              Setting the connection of the pyranometer for optional measurement with a slide button
  - ON     : Connected = communication is connected.
  - OFF    : Disconnected = communication is not connected.

### <Pyranometer 2 Information>

- Model                      Indicating the model name of the connected pyranometer.
- Irradiance                  Indicating the measured irradiance value of the connected pyranometer.  
(Unit is W/m<sup>2</sup>)
  
- Temperature                Indicating the measured sensor temperature value of the connected pyranometer. (Unit is degrees C)
  
- RH                          Indicating the measured internal humidity value of the connected pyranometer. (Unit is %RH)
  
- Tilt                         Indicating the measured value of the installation angle in the Tilt direction of the connected pyranometer. (Unit is degrees)
  
- Roll                         Indicating the measured value of the installation angle in the Roll direction of the connected pyranometer. (Unit is degrees)

(Note) When the optional pyranometer is not connected, 'N/A' is indicated in all items.

## Changing settings values (✎)

### 1 Start operation

Clicking on the pencil mark ([A-1] or [A-2]), will cause the text color of modifiable parameters (① and ②) to turn blue, and an editing mark C (③) to be shown.

0076 Local Time: 13:54:16

Dashboard  
RSB-02  
Add New System

RSB-02

COMMUNICATION

RSB-02 Communication

COM Port:	COM5
MODBUS Address:	1
Baudrate:	19200
Parity:	None
Stop Bits:	1
Comm Status:	Connected
System Status:	No Flags

RSB-02 Model Information

Serial No:	1042
Firmware Version:	233
GPS Satellites:	3
GPS Timestamp:	08/14/2024 13:54:14
Lat,Long:	35.67, 139.67
Elevation:	54.15
Azimuth:	241.46

Pyranometer 1 Communication

Node:	2
Connection Status:	Connected

Pyranometer 1 Information

Model:	MS-805
Irradiance:	35.2

APPLY CHANGES

### 2 Change the setting value (fill in the pyranometer address)

Since ① is saved data, it should be changed only when necessary.

Input the last two digits of the pyranometer serial number for ②. Input confirmation ④ **APPLY CHANGES** will turn blue **APPLY CHANGES**. After confirming the change, click on it to go back from **APPLY CHANGES** to **APPLY CHANGES** and save the settings.

## Measurement Mode, Installation screen

### Measurement Mode

Change to Measurement Mode. The parameters that can be changed differ depending on the mode.

**MEASUREMENT MODE**

Displaying and changing between Measurement Modes ① through ③

Select Measurement Mode

- ①  RSB Mode
- ②  TSB Mode
- ③  Manual Mode

Band Angle Offset: 0

Manual Band Angle: 0

Current Mode: RSB Offset: 10

④ SET

**Band Parameters**

The parameters shown in blue in each mode can be changed. Select a numeric value to change it.

If the value input is outside of the input range, it will be shown in red.

**Commit change**

If the value input is outside of the input range, a warning screen will be shown and the original value will be maintained.

**INSTALLATION MODE**

Selected Item	Details	Modifiable Parameters	Indication	Default	Change Instructions	
<b>Select Measurement Mode</b>						
①	RSB Mode	Offset the band-angle and measure	Band Angle offset	5-15 or 0	10	
			Manual Band Angle	0-180	0	Not modifiable
			Current Mode		RSB	
②	TSB Mode	Move the band to face the sun	Band Angle offset	0-10	10	Not modifiable
			Manual Band Angle	0-180	0	Not modifiable
			Current Mode		TSB	
③	Manual Mode	Manually secure the band-angle and measure	Band Angle offset	0-10		Not modifiable
			Manual Band Angle	0-180	0	
			Current Mode		TSB	
④	BEGIN	Commit changes	Current Mode	Changes OK: Displays "Updating" followed by the selected mode Changes Not OK: Displays a warning screen, then restores the previous data Invalid value entered: The entered characters turn red and cannot be written		

Installation Mode

Clicking [BEGIN] causes the installation instructions screen to be shown.

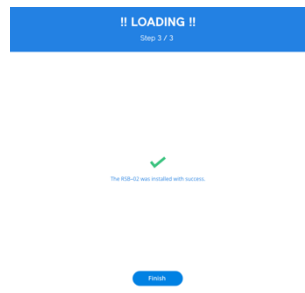
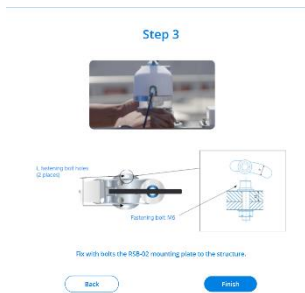
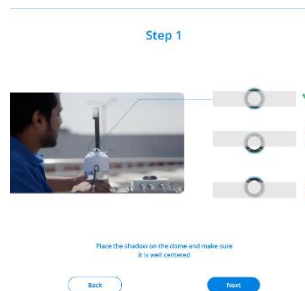
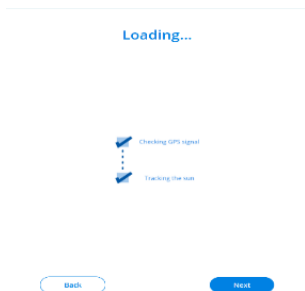
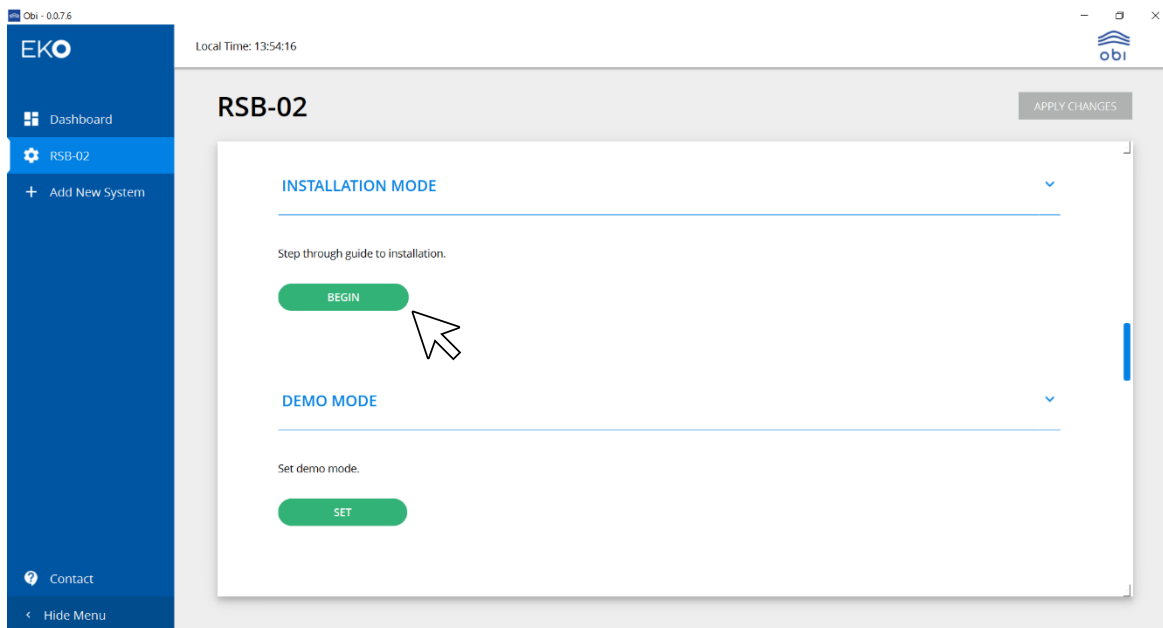

## Demo Mode, Manual GPS Mode Screens

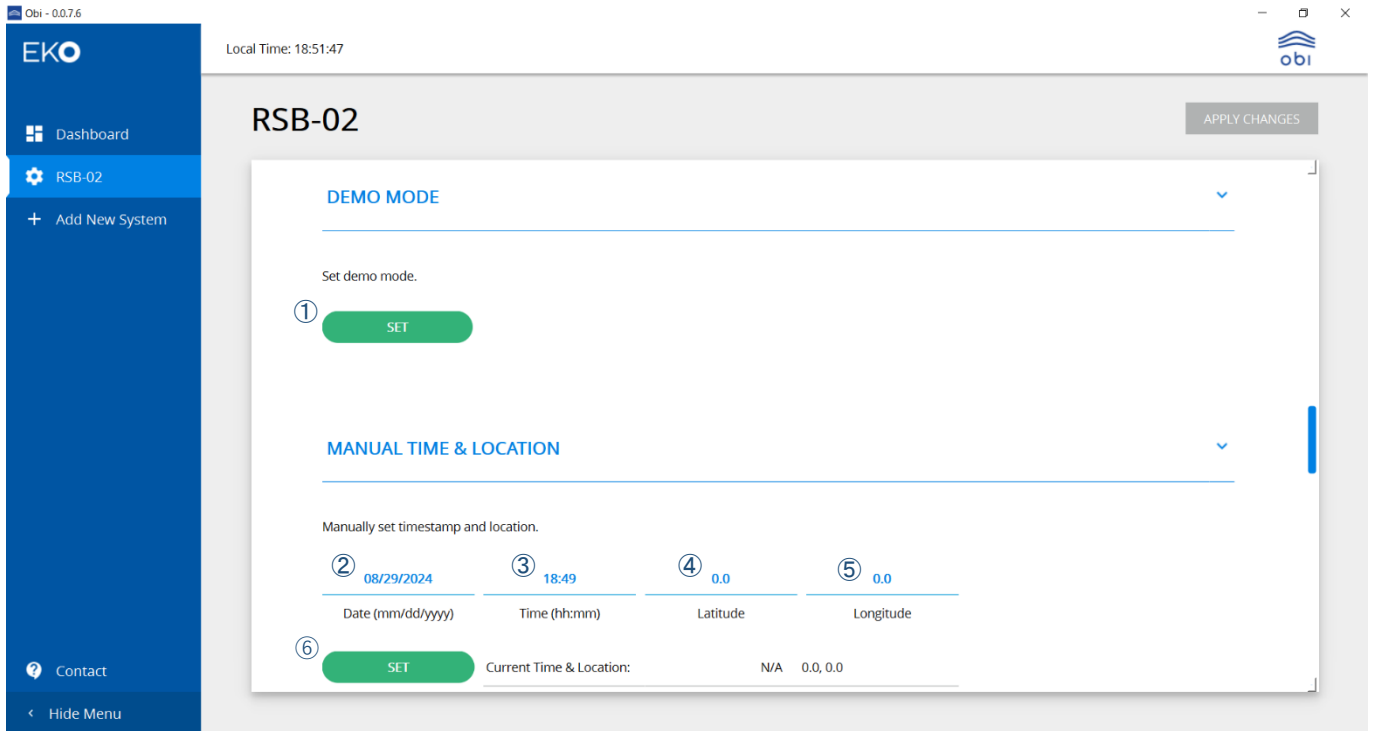

### Demo Mode

Clicking [① SET] causes the device demonstration operation to start, and the indication changes from [SET] to [STOP].

In demonstration mode, typical daytime GPS values are set. If the previous operation mode was RSB mode, RSB operation is performed. If the previous operation mode was TSB mode, TSB operation is performed. Click [STOP] to halt the demonstration operation.

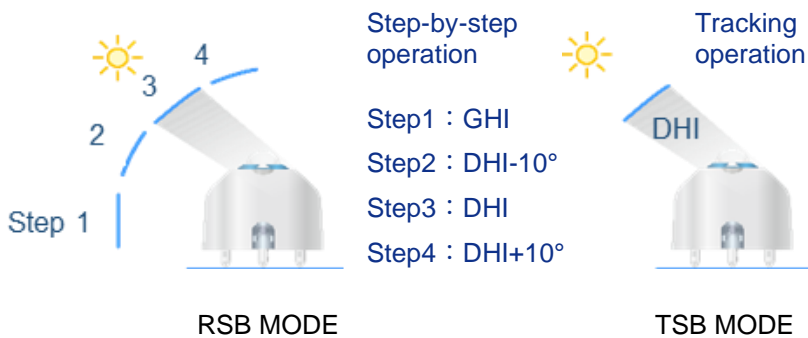

## MANUAL TIME & LOCATION

To use separate GPS information (location information), instead of the GPS data in the C-box, define the on-board time information and location manually.

Enter the setting values ② through ⑤, then click [⑥ BEGIN] to begin measurement with the set GPS information.

Item	Entry Items	Indication	
②	Date	Start of measurement (date)	month/day/year
③	Time	Start of measurement (time)	HH : mm
④	Latitude	Measurement location (Latitude)	deg
⑤	Longitude	Measurement location (Longitude)	deg
⑥	SET	When you press the button down, the operation starts from the measurement start time at the input location.	

## C-BOX SETTINGS, DATA, UPDATES Screens

The screenshot shows the EKO RSB-02 interface. The top left corner displays 'EKO' and 'obi - 0.07.6'. The top right corner shows 'Local Time: 19:44:01' and the 'obi' logo. The main content area is titled 'RSB-02' and includes an 'APPLY CHANGES' button. The 'C-BOX SETTINGS' section contains the following text and buttons:

- Step through guide to calibrate the band position. Current Calibration Value: 45
- ① **BEGIN**
- Perform a factory rest of the C-BOX.
- ② **RESET**

Below the settings is a 'DATA' section. A 'Hide Menu' button is visible at the bottom left of the sidebar.

### C-BOX SETTINGS

Use this [① BEGIN] button to calibrate the absolute position of the motor encoder. Use this correction operation when the shadow band shifts from its original position (90°) due to replacement, re-tightening, or change over time. Also, use [② RESET] to initialize the parameters inside the C-Box. This operation allows you to restore the factory default parameter settings.

# 1 Start operation

Click [① BEGIN] to start calibration mode. Clicking [NEXT] releases the shadow band drive and allows the shadow band to be moved by hand.

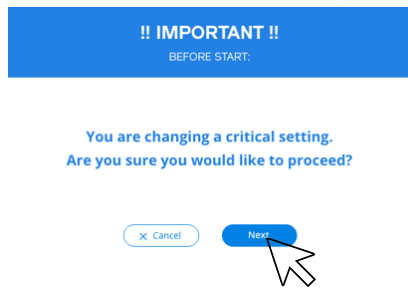

# 2 Correct the shadow band position

Check the tightness of the fixed portion of the shadow band, and click [NEXT] to manually adjust the shadow band position to 90°.



# 3 Save the settings

Click [NEXT] once the rotation position is correct at 90°.

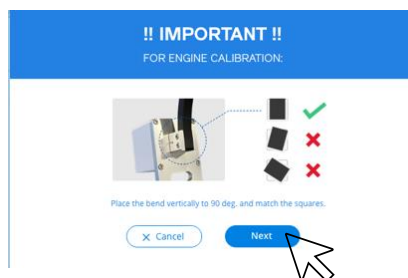

# 4 Confirm and save the settings

The following screen will be displayed while writing until the correction is complete. Click [Finish] to return to the previous screen.

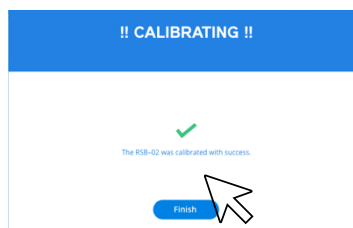
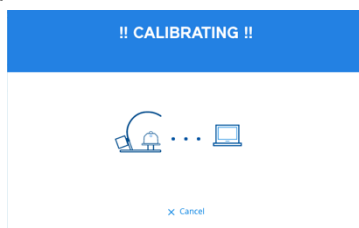

Data

Save the measurement log data as a text file.

# 1 Select the folder to save the file in

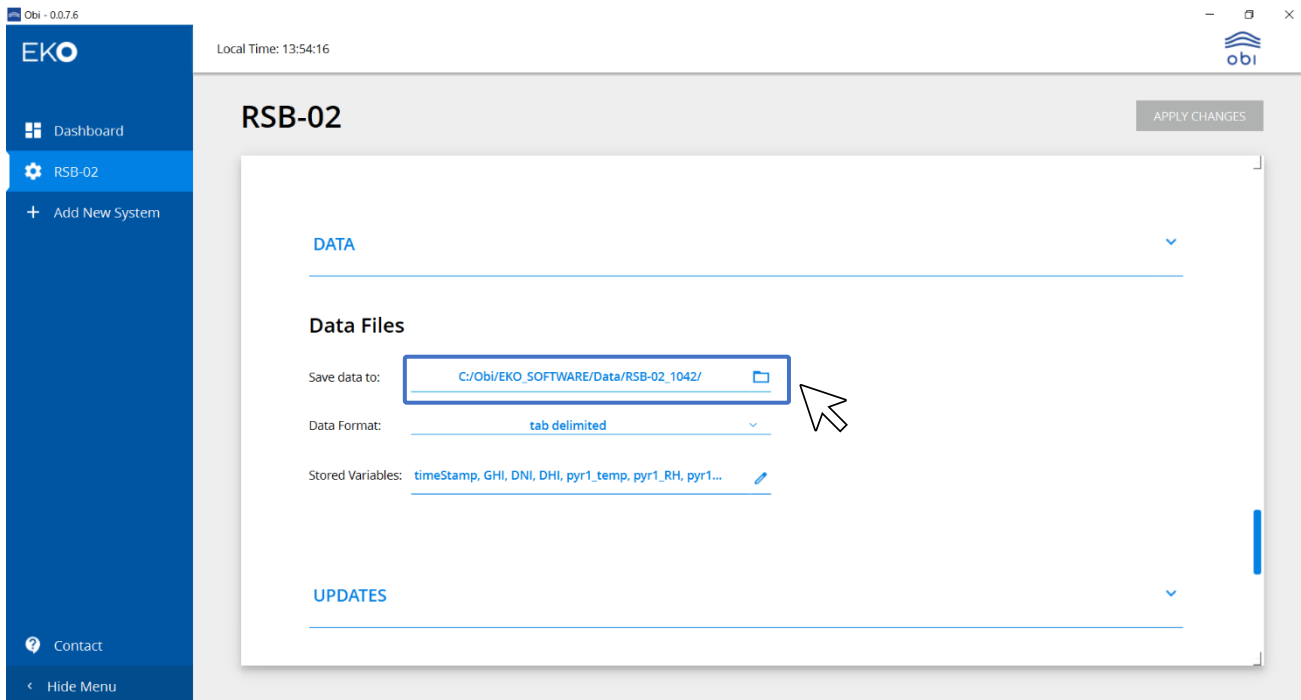

# 2 Click [Select Folder]

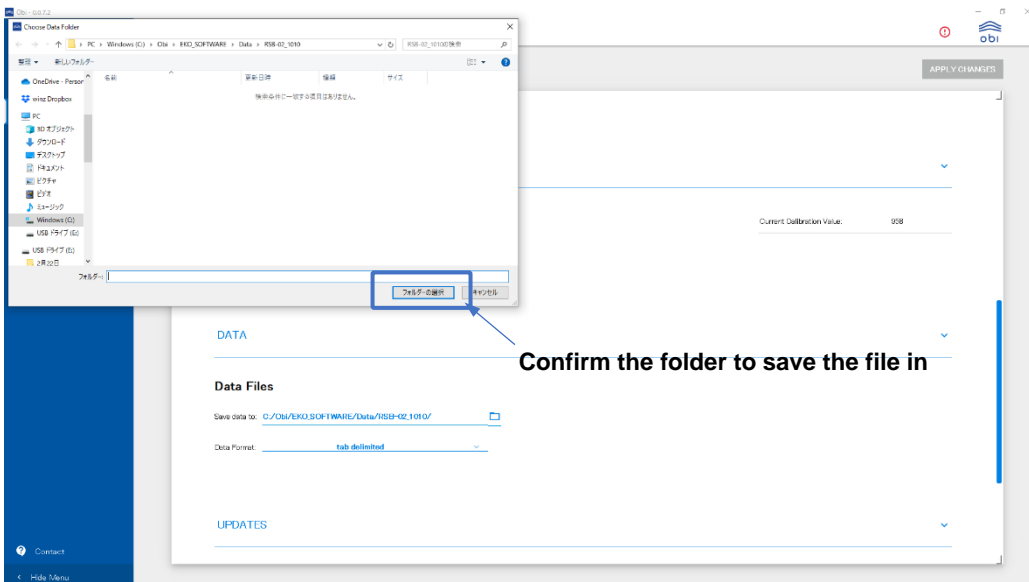

### 3 Select the data file format

Select the data file format from the pull-down menu.

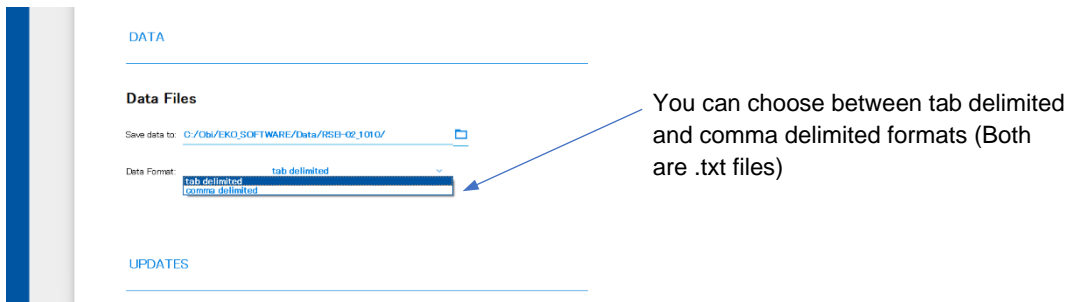

### 4 Select the data to be saved

Clicking on the pencil mark next to the item and choose the data to be saved.

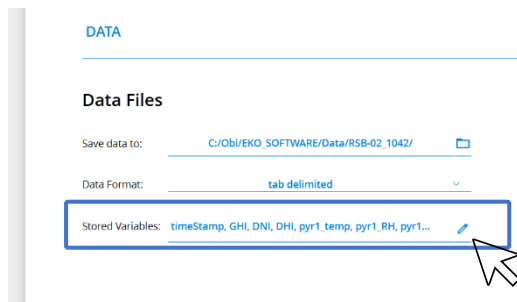

## Update

If necessary, update the firmware on the C-BOX or Obi software .

Please download the updated file from our website in advance.

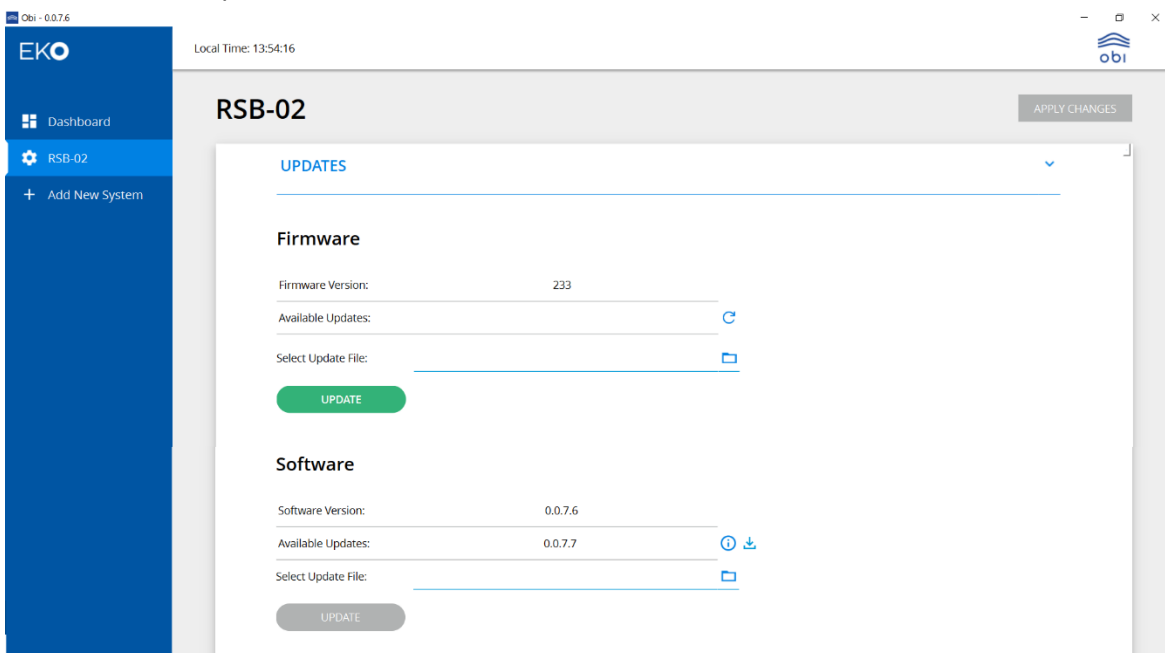

## 1 Call the update file

Execute the file from where it is saved on your PC.

## 2 Perform the update

Click [UPDATE] to change settings from the update file and complete the update.

In case of the firmware, once the update is complete, turn the C-Box off and then on again.

In case of the software, once the update is complete, restart the software.

To remove the RSB-02 tied to the Obi software, click [REMOVE INSTRUMENT].  
After clicking, a screen confirming the removal will appear, and press [Remove] .

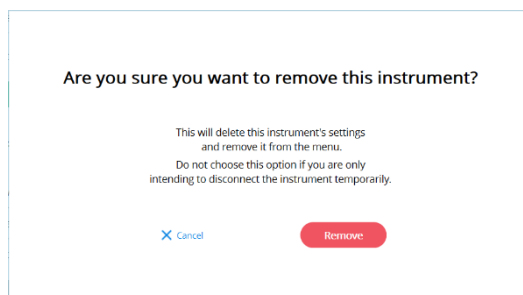
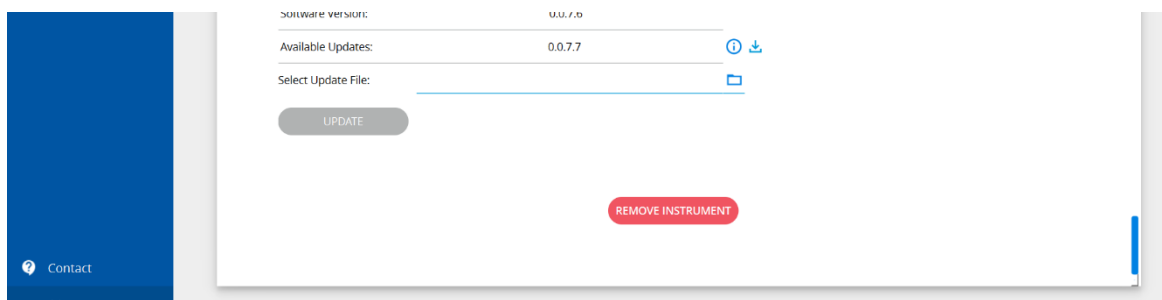

## A-3-8. Measurement Screen

Select [Dashboard] from the drop-down menu to view the measurement data.

The screenshot shows the 'Overview' section of the measurement screen. It includes a status bar, a table of measured values, a line graph, and a legend. Numbered callouts identify the following elements:

- 1 Connected device
- 2 Connection status
- 3 GPS timestamp
- 4 Measured values
- 5 Environmental data
- 6 Measurement Mode
- 7 Graph display range
- 8 Data logging On/Off
- 9 Graph display color
- 10 Measurement graph display

INSTRUMENT	STATUS	Timestamp	GHI	DNI	DHI	TEMP	HUMIDITY	TILT	ROLL	MEASUREMENT MODE
RSB-02	<span style="color: green;">●</span>	08/14/2024 13:54:14	35.1	0.0	35.6	31.2	32.3	0.0	0.0	RSB Offset: 10



Latest Measurement

View: 10 min All Day

Log Data

MS-805H Plus+

- GHI
- DNI
- DHI

Item		Indication		Operation															
①	instrument	MS80SH Plus+		Display only															
②	Status	<input checked="" type="radio"/>	Connected																
		<input type="radio"/>	Not connected																
③	Timestamp	M/d/y/h:m:s																	
④	Measurement	Irradiance	GHI			W/m <sup>2</sup>													
			DNI																
			DHI																
⑤	Environment	TEMP	deg																
		Humidity	%																
		Tilt	deg																
		Roll	deg																
⑥	Measurement Mode	RSB/TSB/Man																	
⑦	View	<input checked="" type="radio"/> 10min	Past 10 minutes	Selection range	<input checked="" type="radio"/> Valid <input type="radio"/> Inactive Use the radio buttons to select the measurement range (10 min or All Day)														
		<input type="radio"/> All Day	0:00-24:00																
⑧	Log Data	<input checked="" type="checkbox"/> ON		ON	Enable data storage														
		<input type="checkbox"/> OFF		OFF	Do not save data														
⑨	RSB-02	<table border="1"> <thead> <tr> <th rowspan="2">Graph color</th> <th colspan="2">Graph display</th> </tr> <tr> <th>Show</th> <th>Hide</th> </tr> </thead> <tbody> <tr> <td>GHI ■</td> <td><input checked="" type="checkbox"/></td> <td><input type="checkbox"/></td> </tr> <tr> <td>DNI ■</td> <td><input checked="" type="checkbox"/></td> <td><input type="checkbox"/></td> </tr> <tr> <td>DHI ■</td> <td><input checked="" type="checkbox"/></td> <td><input type="checkbox"/></td> </tr> </tbody> </table>		Graph color	Graph display		Show	Hide	GHI ■	<input checked="" type="checkbox"/>	<input type="checkbox"/>	DNI ■	<input checked="" type="checkbox"/>	<input type="checkbox"/>	DHI ■	<input checked="" type="checkbox"/>	<input type="checkbox"/>	<p><b>Switch graph display</b> Clicking the graph display mark  toggles between show  and hide .</p> <p><b>Switch graph display color</b> Click the graph display icon ■ to select the display color (3 colors).</p>	
Graph color	Graph display																		
	Show	Hide																	
GHI ■	<input checked="" type="checkbox"/>	<input type="checkbox"/>																	
DNI ■	<input checked="" type="checkbox"/>	<input type="checkbox"/>																	
DHI ■	<input checked="" type="checkbox"/>	<input type="checkbox"/>																	
⑩	Irradiance (Graph)	Measurement data graph for GHI, DNI, and DHI		Display only															

### A-3-9. Save measurement data

Save Data saves the collected data for the measurement period when “ ⑧ Data logging” is ON.

Time	GHI	DNI	DHI	Temp	Humidity	TiltX	TiltY
14:03:28	24.6	0	24.5	28.6	30.1	6553.5	0
14:03:43	24.6	0	24.7	28.6	30.1	0	0
14:03:58	24.5	0	24.7	28.6	30.1	0	0
14:04:13	24.3	0	24.5	28.6	30.1	0	0
14:04:28	23.8	0	24.3	28.6	30.1	0	0
14:04:43	23.1	0	23.8	28.5	30.1	0	0
14:04:58	22.3	0	23.1	28.5	30.1	0	0
14:05:07	21.3	0	22.3	28.5	30.1	0	0
14:05:22	20.5	0	21.3	28.5	30	0	0

## A-4. Updating Firmware and Software

---

The C-BOX firmware and Obi software will be updated on an irregular basis as the device is improved and updated. We will post software/firmware updates to our website, so please check back regularly.



**EKO Asia, Oceania**

**EKO INSTRUMENTS CO., LTD.**

1-21-8 Hatagaya, Shibuya-ku, Tokyo 151-0072 Japan

P. 03.3469.6711

F. 03.3469.6719

[info@eko.co.jp](mailto:info@eko.co.jp)

[www.eko.co.jp](http://www.eko.co.jp)

**EKO North America**

2570 North First Street,  
Suite 200, San Jose,  
CA 95131, USA

P. +1-408-977-7751

F. +1-408-977-7741

[sales-usa@eko-instruments.com](mailto:sales-usa@eko-instruments.com)

[www.eko-instruments.com](http://www.eko-instruments.com)

**EKO Europe,  
Middle East, Africa,  
South America**

Lulofsstraat 55, Unit 28,  
2521 AL, Den Haag,  
The Netherlands

P. +31 [0]70 3050117

[sales-eu@eko-instruments.com](mailto:sales-eu@eko-instruments.com)

[www.eko-instruments.com](http://www.eko-instruments.com)